

ALPINE SERVICE MANUAL

RDS MP3/WMA CD Receiver

MP3

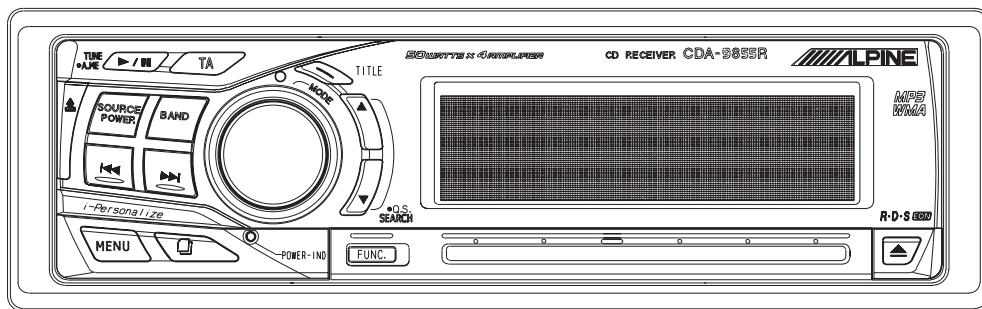

3 / 05-A
68E38380S01



CDA-9855R

<Cautions for Safe Repair Work>



The following cautions will prevent accidents in the workplace and will ensure safe products.

*The symbols indicate caution is needed to prevent injuries and damage to property.



The symbols and their meanings follow.

 Warning	If you ignore this symbol and handle the product incorrectly or unsafely, serious injury or death may result.
 Caution	If you ignore this symbol and handle the product incorrectly or unsafely, injury or only material damage may result.



*The following symbols indicate two levels of cautions.



 When you see this symbol, you have to be very careful.	
 When you see this symbol, you have to follow the instructions there.	



Warning

 Do not look squarely into the laser light coming from the pickup. You may lose your sight.	 Fuse Caution Always use a designated fuse. Use of an incorrect fuse may result in a fire.
--	--

Caution

 Do not allow wiring to be caught in the screw/chassis. If wiring is caught in the screw/chassis, it may cause a short circuit, resulting in a fire.	 Battery Caution Use the designated battery. Confirm the correct polarity and seat of the battery. An incorrect battery or an improperly connected or seated battery may result in a fire.
---	---

 High Temperature Caution Touching the heat sink may cause severe burns.	 Designated Parts Caution Look up the part list and ensure that only designated parts are used to prevent problems or accidents.
---	---

 Reverse Power Supply Connections or Misconnections Caution Reverse power supply connections or misconnections may cause ignition problems and smoke may result.	 Wiring Caution Ensure that the wiring is correct when rewiring to prevent problems with ignition/breakdown.
---	---

 Soldering Caution Hot solder from solder splash may cause severe burns.	 Wear Gloves Wear gloves to prevent electrical shocks or injury from the end face of the metal.
---	--

Contents

Packing Assembly Parts List	4
Packing Method View	4
Specifications	5 , 6
Extension Cable	7
Adjustment Procedures	8 to 11
Block Diagram	12
Parts Layout on P.W.Boards and Wiring Diagram	13 to 17
Schematic Diagram	18 to 26
Terminal Voltage of IC/TR	27 to 40
Description of IC Terminal	41 to 46
Exploded View (Cabinet)	47 , 48
Exploded View (CD Deck Mechanism) (DP23S8DA)	49

NOTE : Due to continuing product improvement, specifications and designs are subject to change without notice.

Packing Assembly Parts List

Symbol No.	Part No.	Description	Symbol No.	Part No.	Description
101	15D00529K02	CASE,INNER	103-4	03A60836Y01	SCR,CUS 5X7 ZN A
102	15D01798K03	CARRYING,CASE	103-5	60T55630W01	BAT,MGN R03(NB)UM-4
103-1	03S60820Y16	SCR,MCH 5X8 ZN A	104	09-02252Z01	ASSY,ANIC-0007-01A
103-2	03S60824Y01	SCR,WEV 1.7X4 ZN A	105	68-02278Z08	O/M AOEU AODL
103-3	36A02449K01	CAP,RUBBER(A)	106	97-02291Z01	ASSY,SBPF00001A

Packing Method View

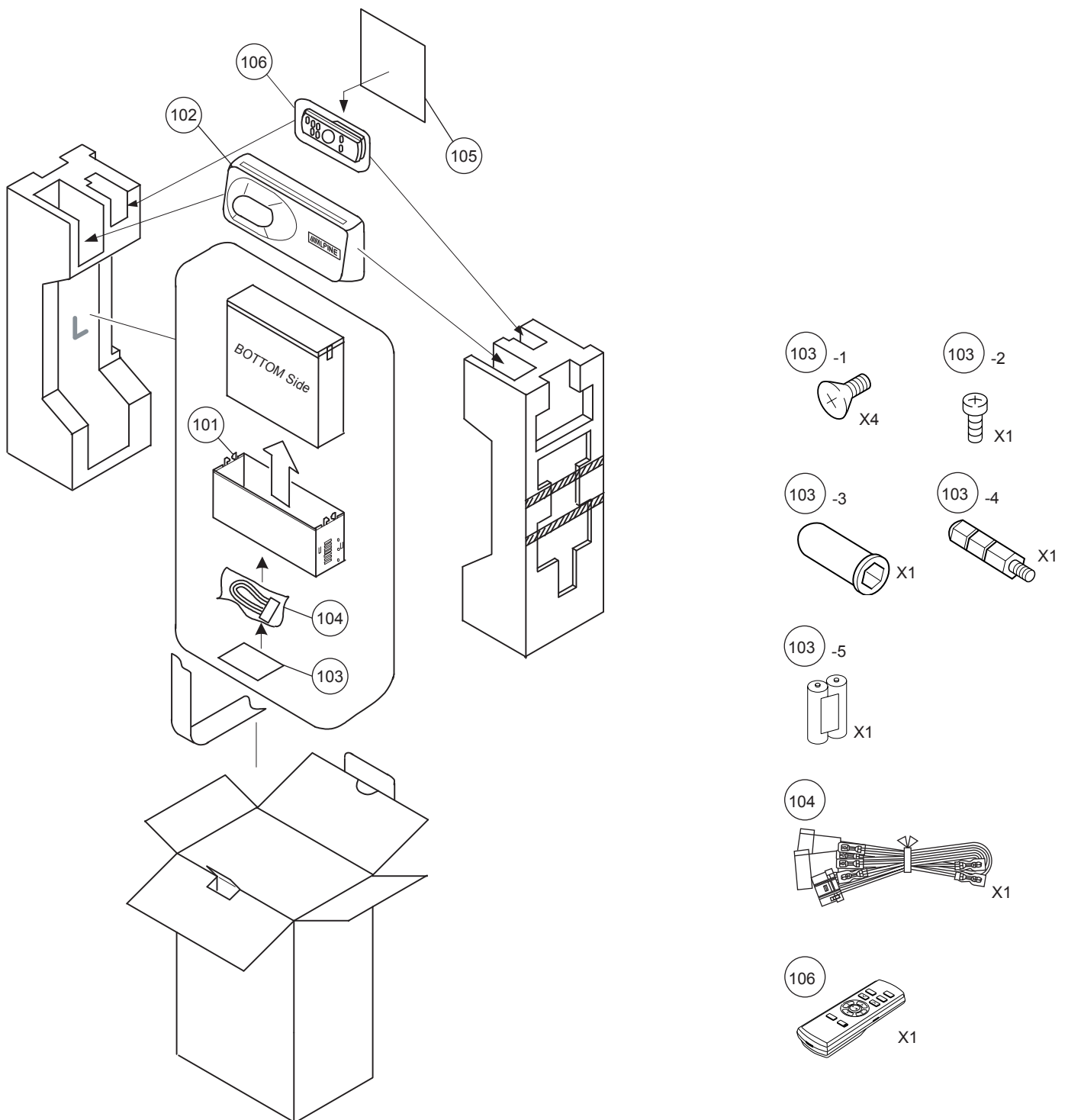

Specifications

< FM RADIO >

Intermediate Frequency	10.7±0.1MHz
Frequency Range	87.5 to 108.0MHz
Usable Sensitivity (30dB S/N, Mono, at 98.1MHz)	20.2dBf
-3dB Limiting Sensitivity (at 98.1MHz)	20.2dBf
Residual Noise (Ref. 400Hz (narrow), at 98.1MHz)	30±10dB
S/N Ratio (at 98.1MHz)	Stereo : 50dB Mono : 55dB
Image Rejection (at 106.1MHz)	40dB
IF Rejection (at 90.1MHz)	60dB
Distortion (Input 60dBu, at 98.1MHz)	1.0%
Frequency Response (Ref. 400Hz, at 98.1MHz)	100Hz : 0±3dB 10kHz : -10±3dB
Stereo Separation (1kHz, at 98.1MHz)	20dB
PS Sensitivity (at 98.1MHz)	36.2dBf

< MW RADIO >

Intermediate Frequency	1st : 10.7MHz 2nd : 450kHz
Frequency Range	531 to 1,602kHz
Usable Sensitivity (20dB S/N, at 999kHz)	36dB
S/N Ratio (at 999kHz)	44dB
Image Rejection (at 1,404kHz)	2nd IF : 50dB
IF Rejection (at 603kHz)	2nd IF : 60dB
Distortion (at 999kHz)	1.5%
Frequency Response (Ref. 400Hz, at 999kHz)	100Hz : -3±4dB 2.5kHz : -5 +3/-5dB

< LW RADIO >

Intermediate Frequency	1st : 10.7MHz 2nd : 450kHz
Frequency Range	153 to 281kHz
Usable Sensitivity (20dB S/N, at 216kHz)	42dB
S/N Ratio (at 216kHz)	44dB
Image Rejection (at 270kHz)	2nd IF : 50dB
IF Rejection (at 162kHz)	2nd IF : 50dB
Distortion (at 216kHz)	1.5%
Frequency Response (Ref. 400Hz, at 216kHz)	100Hz : -3±4dB 2.5kHz : -5 +3/-5dB

< CD SECTION >

System	Optical (Compact Disc System)
Channel Balance (1kHz)	CD : TCD-782 : 0±3dB MP3 : SCD-5100 (FOLDER4-128kbps) : 0±3dB WMA : SCD-5100 (FOLDER10-128kbps) : 0±3dB
Distortion (1kHz)	CD : TCD-782 : 0.1% MP3 : SCD-5100 (FOLDER4-128kbps) : 0.1% WMA : SCD-5100 (FOLDER10-128kbps) : 0.1%

CDA-9855R

Frequency Response (Ref. 1kHz, 0dB)	CD : TCD-782 : 17Hz : 0±3dB 127Hz : 0±2dB 10.007kHz : 0±2dB 19.997kHz : -2±4dB MP3 : SCD-5100 (FOLDER4-128kbps) : 17Hz : 0±3dB 127Hz : 0±2dB 10.007kHz : 0±2dB 19.997kHz : -2±4dB WMA : SCD-5100 (FOLDER10-128kbps) : 17Hz : 0±3dB 127Hz : 0±2dB 10.007kHz : 0±2dB 19.997kHz : -2±4dB
S/N Ratio	CD : TCD-782 : 85dB MP3 : SCD-5100 (FOLDER4-128kbps) : 85dB WMA : SCD-5100 (FOLDER10-128kbps) : 85dB
Separation (1kHz)	CD : TCD-782 : 55dB MP3 : SCD-5100 (FOLDER4-128kbps) : 55dB WMA : SCD-5100 (FOLDER10-128kbps) : 55dB
De-Emphasis (Ref. 1kHz, 0dB)	CD : TCD-782 : 4kHz : -20±3dB 16kHz : -20±3dB

< CD Deck Mechanism >

Test Disc	TCD-782
RF Waveform Amplitude	1.2±0.5Vp-p
Quantity of Jitter	Less than 30nsec
Measurement Angle Range	Front and Rear : -15°~75° Right and Left : ±45°
Laser Current	Initial value ±5mA (The initial value of laser current is indicated on the Flexible Cable.)

< Pickup >

Wave Length	795nm
Laser Power	CLASS I

< GENERAL >

Power Supply	DC14.4V
Power Output (TCD-782 (1kHz, 0dB), T.H.D. 10%) / Impedance	17W / ch / 4 ohm
Pre Output (at Vol. Max, TCD-782 (1kHz, 0dB), T.H.D. 1% or less) / Impedance	4V±2dBV / ch / 10k ohm
Back Up Current (ACC-OFF After 1 minute)	5mA
Dimensions (W x H x D)	Chassis : 178 x 50 x 160mm Nose : 188 x 58 x 24.6mm
Weight	1.6kg

NOTE : Due to Continuing product improvement, specifications and designs are subject to change without notice.

Extension Cable

*Always connect the Extension Cable when making checks of voltage and repair.

DVD Deck Mechanism
DP23S8DA

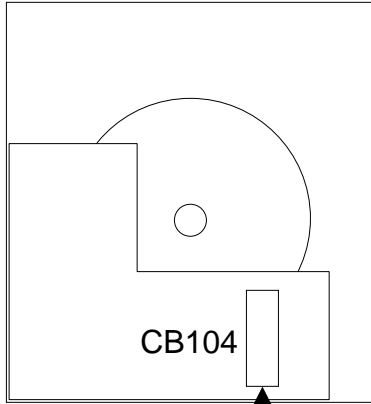

MAIN P.W.Board

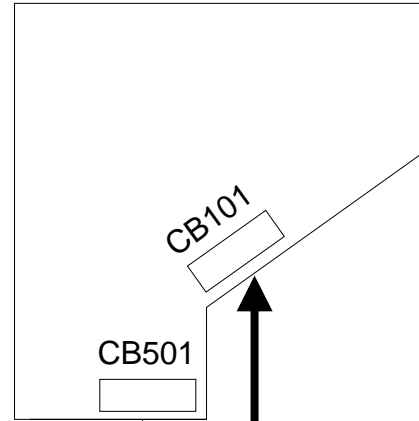

(1)



(2)



FRONT P.W.Board



(1) 01E29616S01

(2) 01V37775S01

Adjustment Procedures

1. FM/MW/LW SECTION

(1) Dummy Antenna Circuit

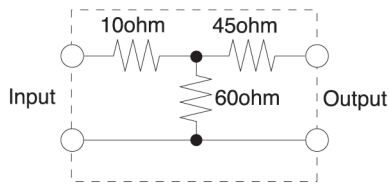

For 50 ohm FM Signal Generator

Figure 1

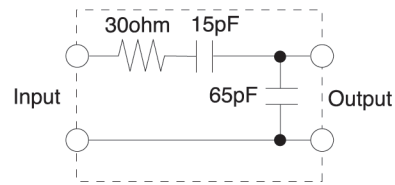

For 50 ohm MW/LW Signal Generator Figure 2

(2) Connections

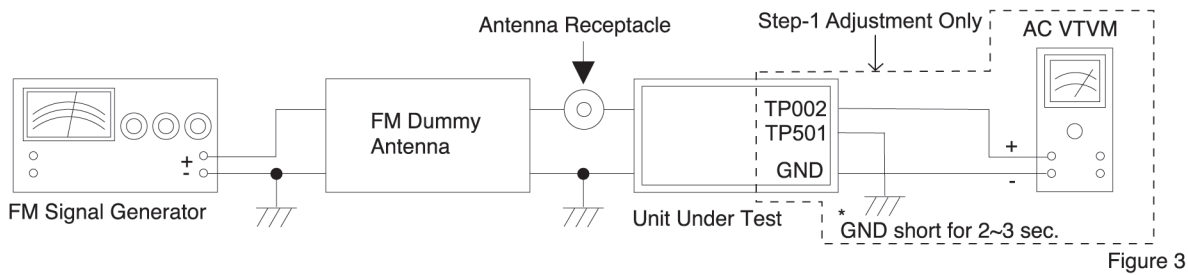

Figure 3

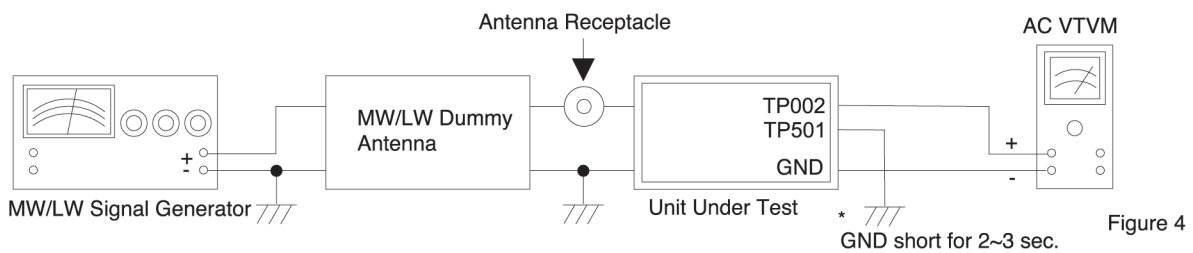

Figure 4

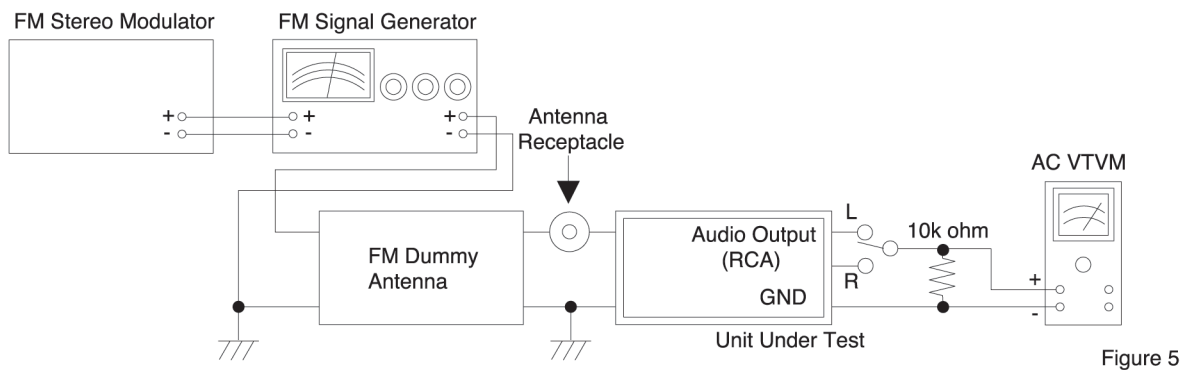

Figure 5

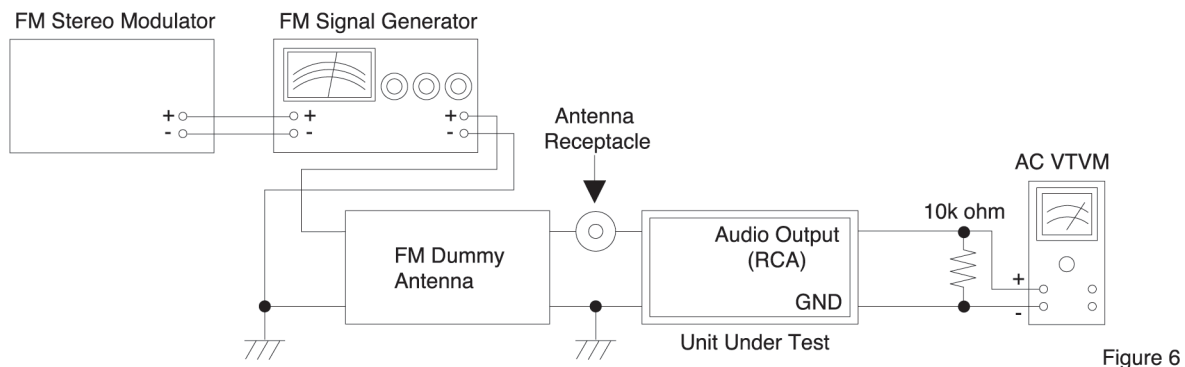

Figure 6

(3) Control Settings

Power Switch ON	Band Switch FM/MW/LW
Fader Control Center Position	T-CORR Non Effect
Balance Control Center Position	EQ FLAT
Treble Control Center Position	DEMO OFF
Bass Control Center Position	Others OFF
MX Non Effect		

(4) Adjustment Procedures

Step	Description	Connection	Signal Generator	Dial Control	Test Point / P.W.Board Coordinates	Adjustment
1	Signal Meter Auto Adjustment (FM)	Figure 3	(1) 87.5MHz, 26dB μ (Mod. OFF)	87.5MHz	TP002 (3-F) TP501 (3-F)	Auto Adjustment: After setting up of Signal Generator, short GND and TP501 (Pull-Down) for 2~3 seconds.
			(2) 87.5MHz, 26dB μ (Mod. OFF)	87.5MHz	TP002 (3-F) TP501 (3-F)	Proceed same Auto Adjustment of step (1) under step (2). (SPEC) TP002 : 1.5 \pm 0.1V \rightarrow OK (SPEC) TP002 : others 1.5 \pm 0.1V \rightarrow NG NOTE : NG : Proceed same Auto Adjustment of step (1) under step (3).
			(3) 87.5MHz, 21~23dB μ (Mod. OFF)	87.5MHz	TP002 (3-F) TP501 (3-F)	Proceed same Auto Adjustment of step (1) under step (3).
			(4) 87.5MHz, 26dB μ (Mod. OFF)	87.5MHz	TP002 (3-F) TP501 (3-F)	Proceed same Auto Adjustment of step (1) under step (4).
2	Det Out-DC OFFSET Adjustment (FM)	Figure 3	(1) 87.5MHz, 26dB μ (Mod. OFF)	87.5MHz	—	" DC OFFSET " displays after finishing S-METER (FM) adjustment.
			(2) 87.5MHz, 26 \rightarrow -20dB μ (Mod. OFF)	87.5MHz	—	The SIGNAL GENERATOR output of 26dB μ is lowered to -20dB μ within 10 seconds.
			(3) 87.5MHz, -20dB μ (Mod. OFF)	87.5MHz	—	When adjustment is finished, the " DC OFFSET " display disappears.
3	Signal Meter Auto Adjustment (MW)	Figure 4	(1) 999kHz, 34dB μ (Mod. OFF)	999kHz	TP002 (3-F) TP501 (3-F)	Auto Adjustment: After setting up of Signal Generator, short GND and TP501 (Pull-Down) for 2~3 seconds.
			(2) 999kHz, 34dB μ (Mod. OFF)	999kHz	TP002 (3-F) TP501 (3-F)	Proceed same Auto Adjustment of step (1) under step (2). (SPEC) TP002 : 1.0 \pm 0.1V \rightarrow OK (SPEC) TP002 : others 1.0 \pm 0.1V \rightarrow NG NOTE : NG : Proceed same Auto Adjustment of step (1) under step (3).
			(3) 999kHz, 29~31dB μ (Mod. OFF)	999kHz	TP002 (3-F) TP501 (3-F)	Proceed same Auto Adjustment of step (1) under step (3).
			(4) 999kHz, 34dB μ (Mod. OFF)	999kHz	TP002 (3-F) TP501 (3-F)	Proceed same Auto Adjustment of step (1) under step (4).

Step	Description	Connection	Signal Generator	Dial Control	Test Point / P.W.Board Coordinates	Adjustment	
4	Signal Meter Auto Adjustment (LW)	Figure 4	(1)	216kHz, 34dB μ (Mod. OFF)	216kHz	TP002 (3-F) TP501 (3-F)	Auto Adjustment : After setting up of Signal Generator, short GND and TP501 (Pull-Down) for 2~3 seconds.
			(2)	216kHz, 34dB μ (Mod. OFF)	216kHz	TP002 (3-F) TP501 (3-F)	Proceed same Auto Adjustment of step (1) under step (2). (SPEC) TP002 : 1.0 \pm 0.1V \rightarrow OK (SPEC) TP002 : others 1.0 \pm 0.1V \rightarrow NG NOTE : NG : Proceed same Auto Adjustment of step (1) under step (3).
			(3)	216kHz, 29~31dB μ (Mod. OFF)	216kHz	TP002 (3-F) TP501 (3-F)	Proceed same Auto Adjustment of step (1) under step (3).
			(4)	216kHz, 34dB μ (Mod. OFF)	216kHz	TP002 (3-F) TP501 (3-F)	Proceed same Auto Adjustment of step (1) under step (4).
5	FM ST Separation (Roll OFF) Adjustment	Figure 5	(1)	—	—	—	Set up of Adjustment Mode : Push [POWER] + [▲] Key at the same time.
			(2)	98.1MHz, 72dB μ (Mod. 400Hz, Dev. 40kHz, Stereo, 1kHz, Lch only)	98.1MHz	Audio Output (RCA)	Push [▲] and [▼] Key, and observe value of separation. Select [▲] and [▼] Key of maximum separation. (SPEC) : separation : more than 20dB.
			(3)	—	—	—	Cancel Adjustment Mode : Push [POWER] + [▲] Key at the same time.
6	Stereo Blend Adjustment (Lch)	Figure 5	(1)	—	—	—	Set up of Adjustment Mode : Push [BAND] + [▲] Key at the same time.
			(2)	98.1MHz, 46dB μ (Mod. 400Hz, Dev. 40kHz, Stereo, 1kHz, Lch only)	98.1MHz	Audio Output (RCA)	Push [▲] and [▼] Key, and observe value of blend. (SPEC) : Blend : 8 \pm 6dB.
			(3)	—	—	—	Cancel Adjustment Mode : Push [BAND] + [▲] Key at the same time.
7	Limiting Adjustment	Figure 6	(1)	—	—	—	Set up of Adjustment Mode : Push [BAND] + [□] Key at the same time.
			(2)	98.1MHz, 24dB μ (Mod. 400Hz, Dev. 40kHz)	98.1MHz	Audio Output (RCA)	Push [▲] and [▼] Key, and observe value of limiting. (SPEC) : Limiting : 3dB.
			(3)	—	—	—	Cancel Adjustment Mode : Push [BAND] + [□] Key at the same time.

Step	Description	Connection	Signal Generator	Dial Control	Test Point / P.W.Board Coordinates	Adjustment	
8	Noise Level Adjustment	Figure 6	(1)	—	—	—	Set up of Adjustment Mode : Push [BAND] + [□] Key at the same time.
			(2)	98.1MHz, 72 --> -20dBμ (Mod. OFF)	98.1MHz	Audio Output (RCA)	Rotary encoder is turned and noise level is adjustment. (SPEC) : Noise Level : 30±10dB.
			(3)	—	—	—	Cancel Adjustment Mode : Push [BAND] + [□] Key at the same time.

Block Diagram

CDA-9855R

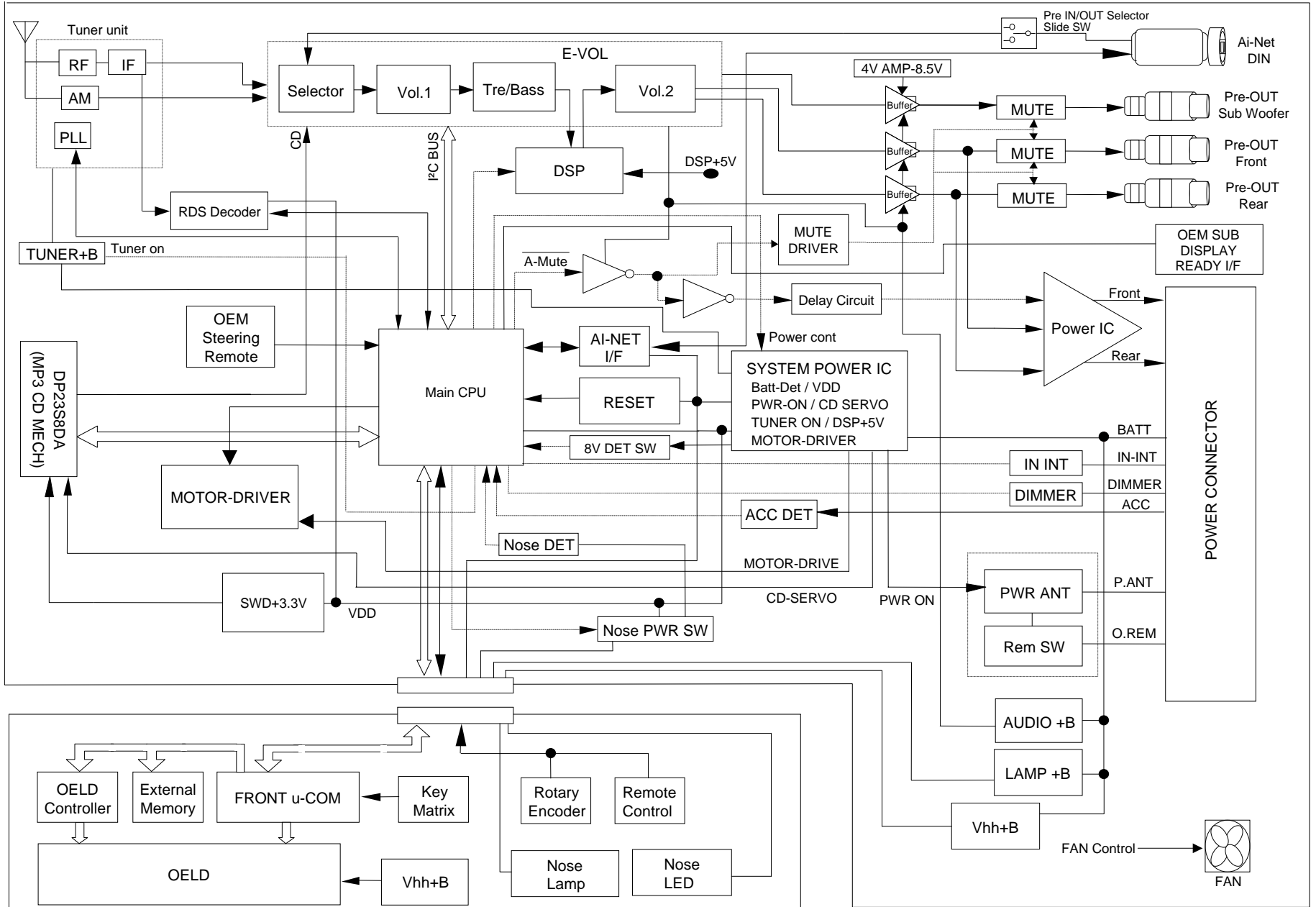

1
2
3
4
5

MAIN P.W.Board (Foil Side View)

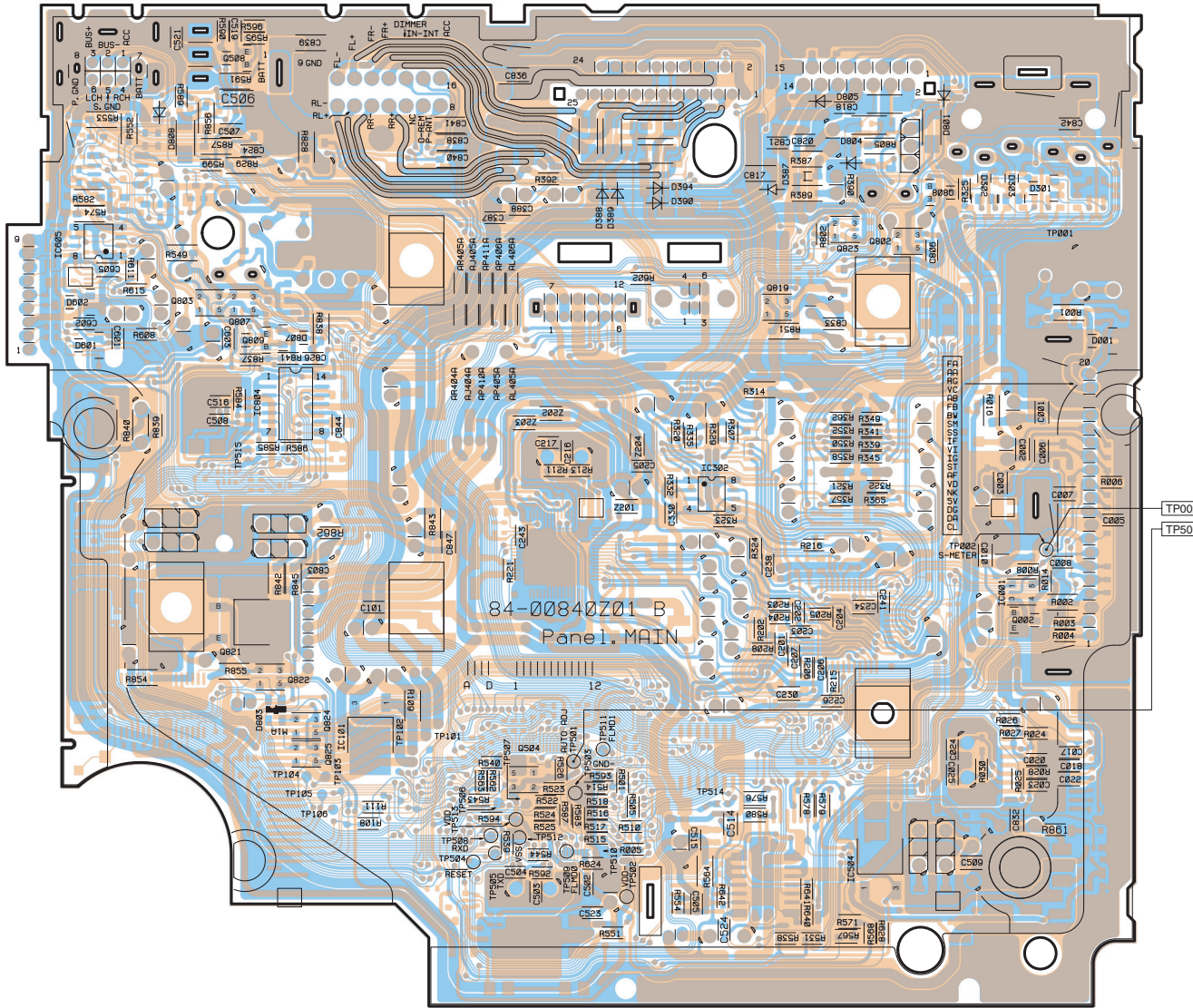

BOX P.W.Board (Foil Side View)

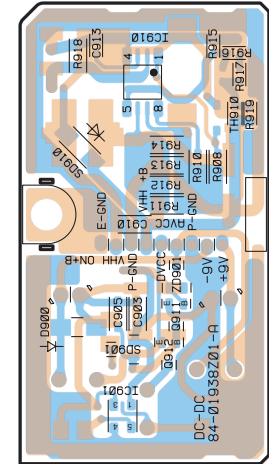

Orange Color Pattern:Component Side Pattern
Blue Color Pattern:Foil Side Pattern

A | B | C | D | E | F | G

1

FRONT P.W.Board (Component Side View)

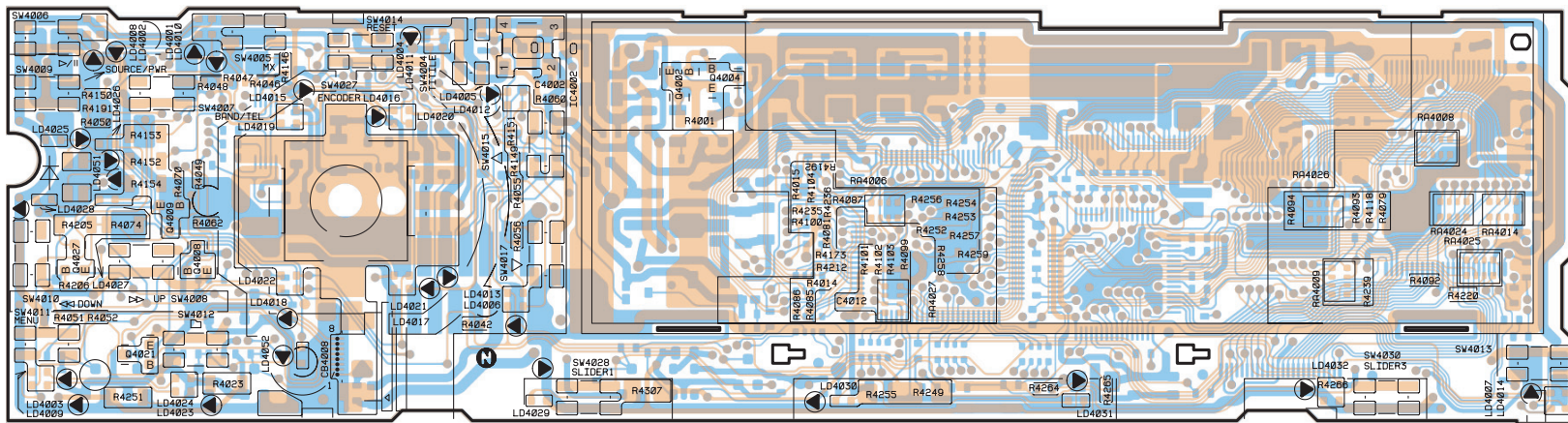

2

To CB4008



(8)

ASSY,SMK010001B (Top Side View)

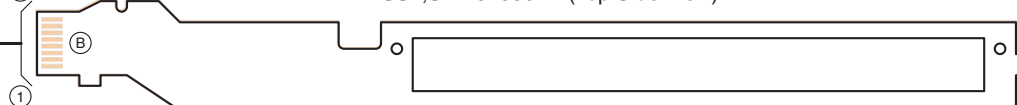

3

4

FRONT P.W.Board (Foil Side View)

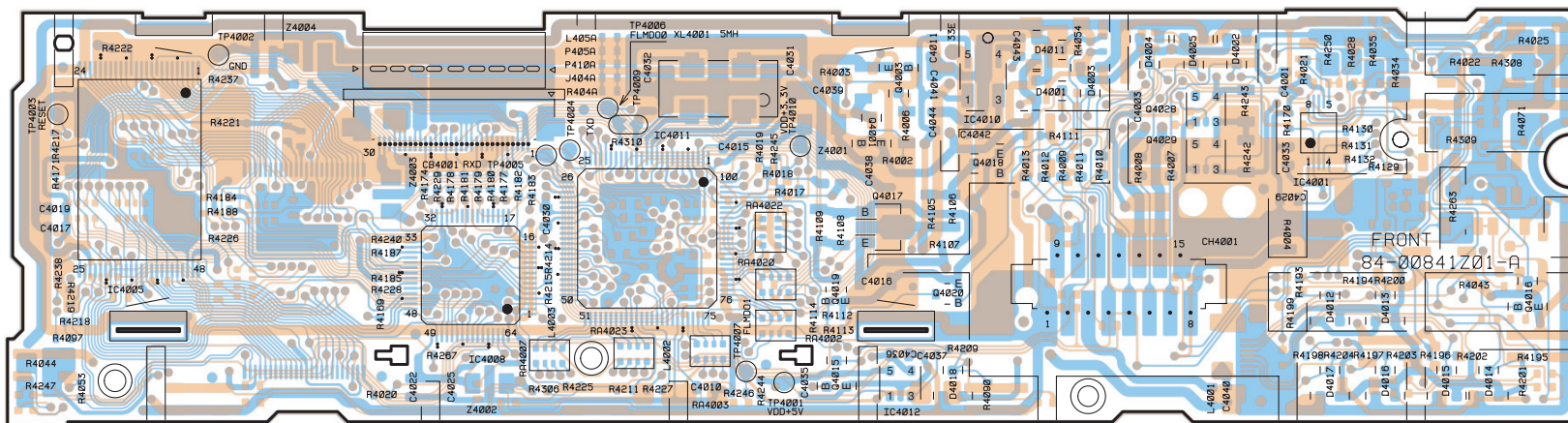

5

To CB4001

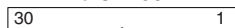

From OELD P.W.Board (CB4504)

To CH4001

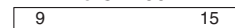

To ASSY, UNIZON CONN 93R

Orange Color Pattern:Component Side Pattern
Blue Color Pattern:Foil Side Pattern

A

B

C

D

E

F

G

1
2
3
4
5

DP-S MAIN P.W.Board
(Foil Side View)

The patterns should be short-circuited, when the PICKUP is removed from DP-S Mechanism.

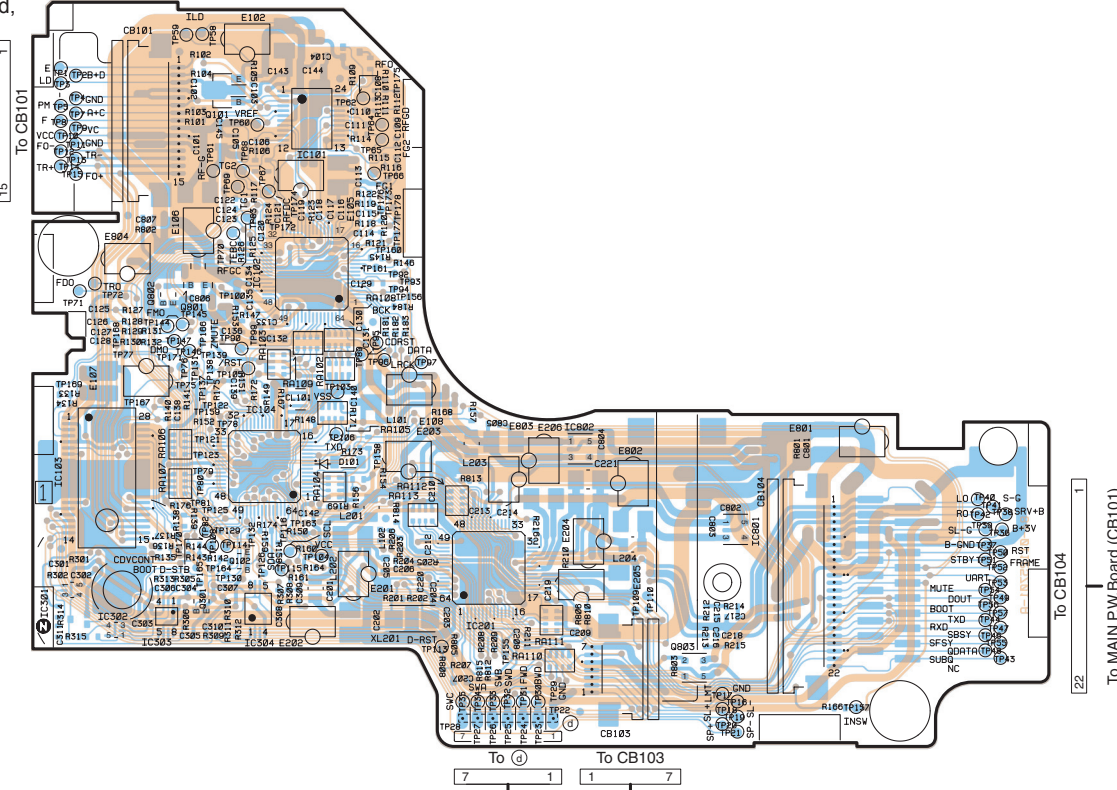
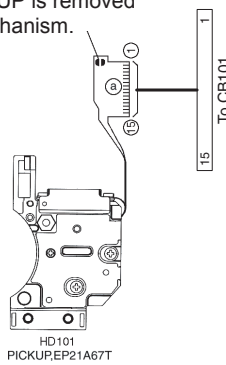

FPC,CONT P.W.Board
(Foil Side View)

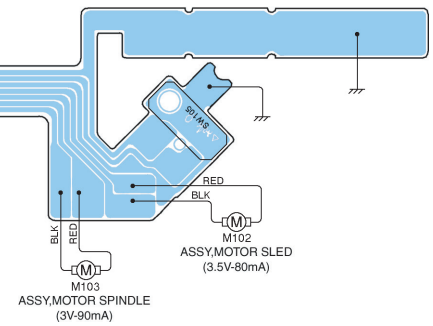

DP-S Switch P.W.Board
(Foil Side View)

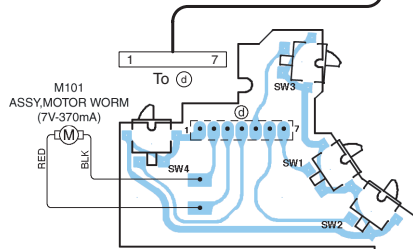

Orange Color Pattern:Component Side Pattern
Blue Color Pattern:Foil Side Pattern

A | B | C | D | E | F | G

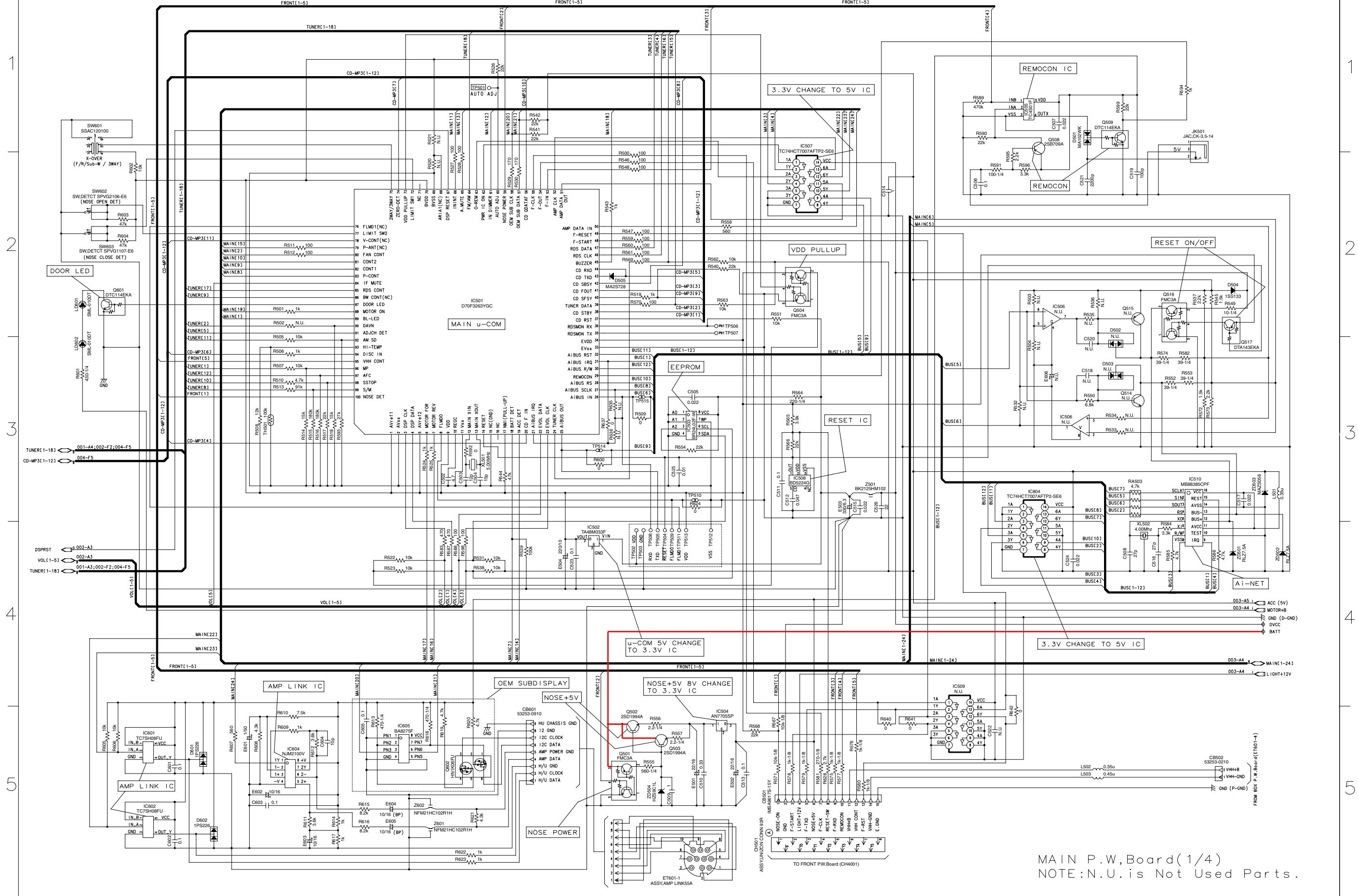

MAIN P.W,Board(1/4)
 NOTE:N.U.is Not Used Parts.

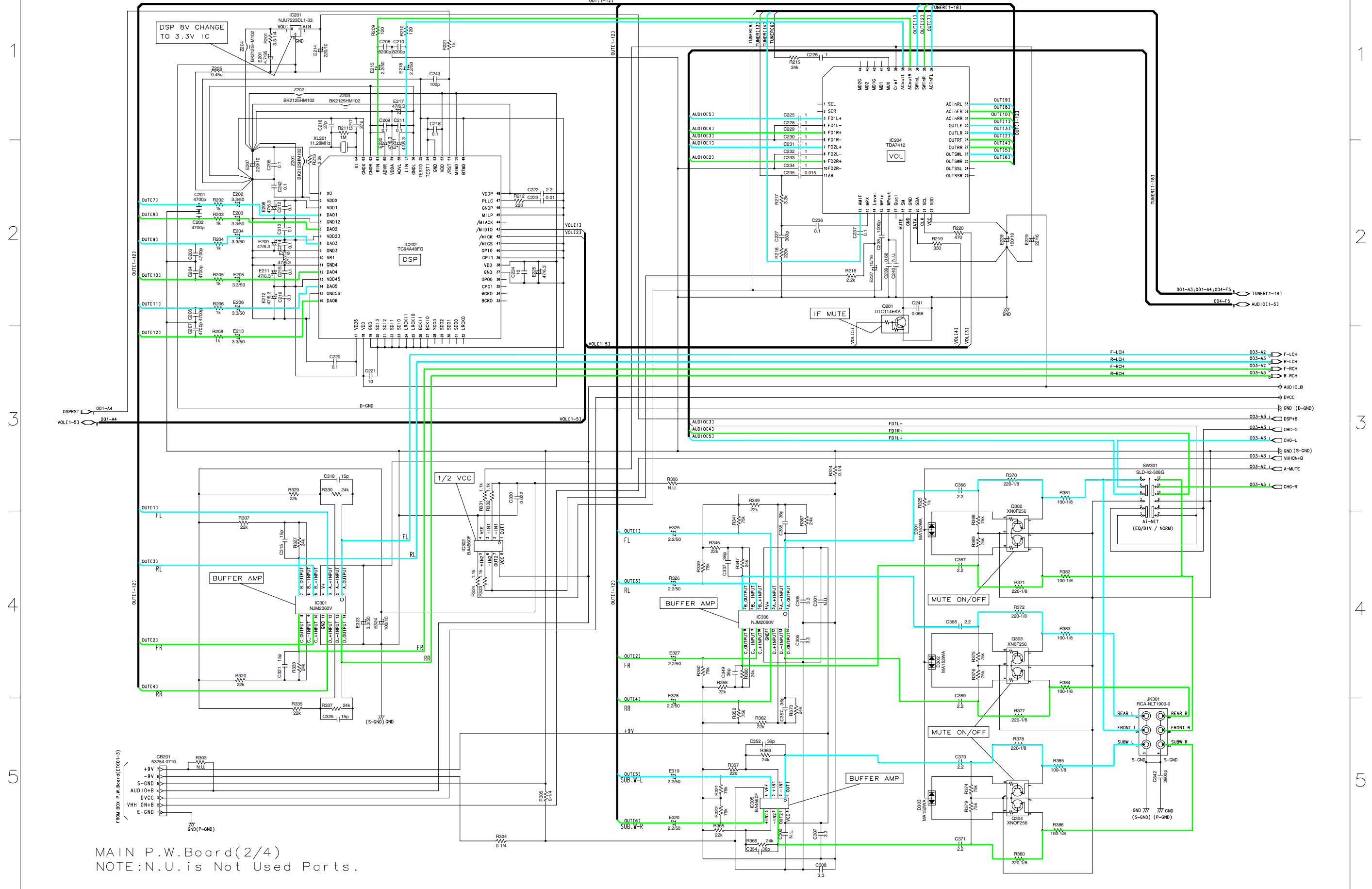

MAIN P.W.Board(2/4)
 NOTE:N.U. is Not Used Parts.

Schematic Diagram(3/9)

CDA-9855R

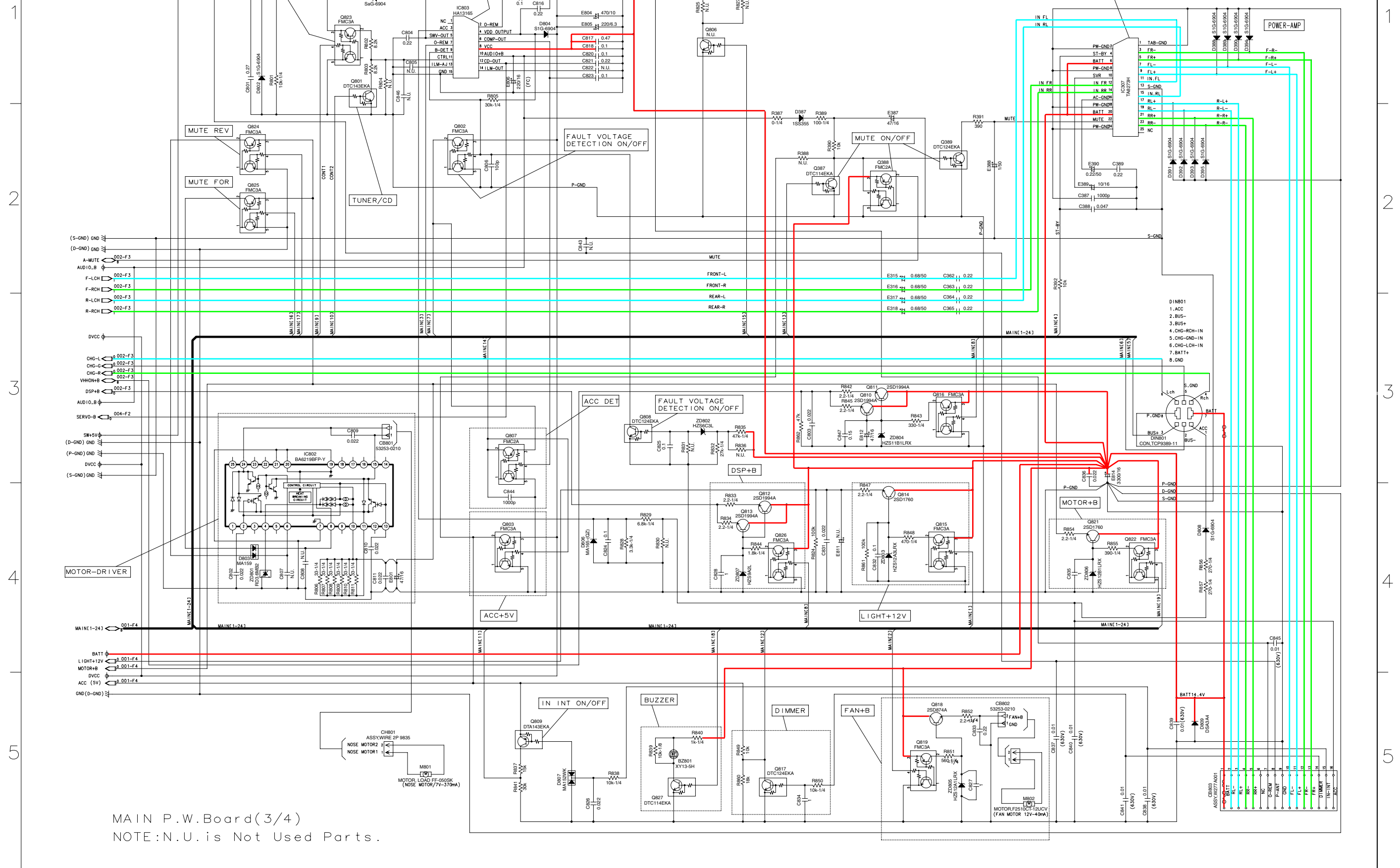

MAIN P.W.Board(3/4)
NOTE:N.U.is Not Used Parts.

Schematic Diagram(4/9)

CDA-9855R

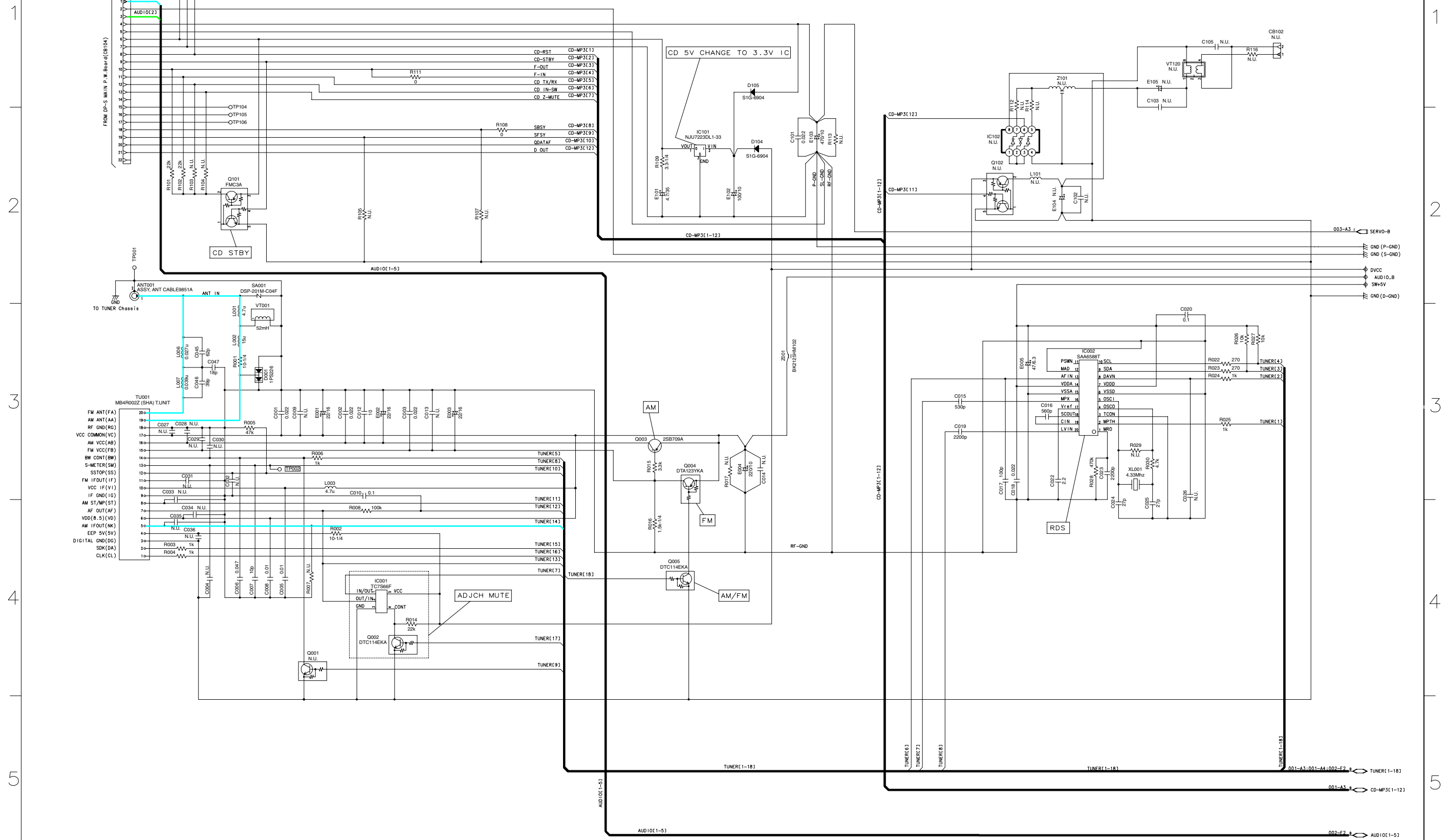

MAIN P.W.Board(4/4)
 NOTE:N.U. is Not Used Parts.

Schematic Diagram(6/9)

CDA-9855R

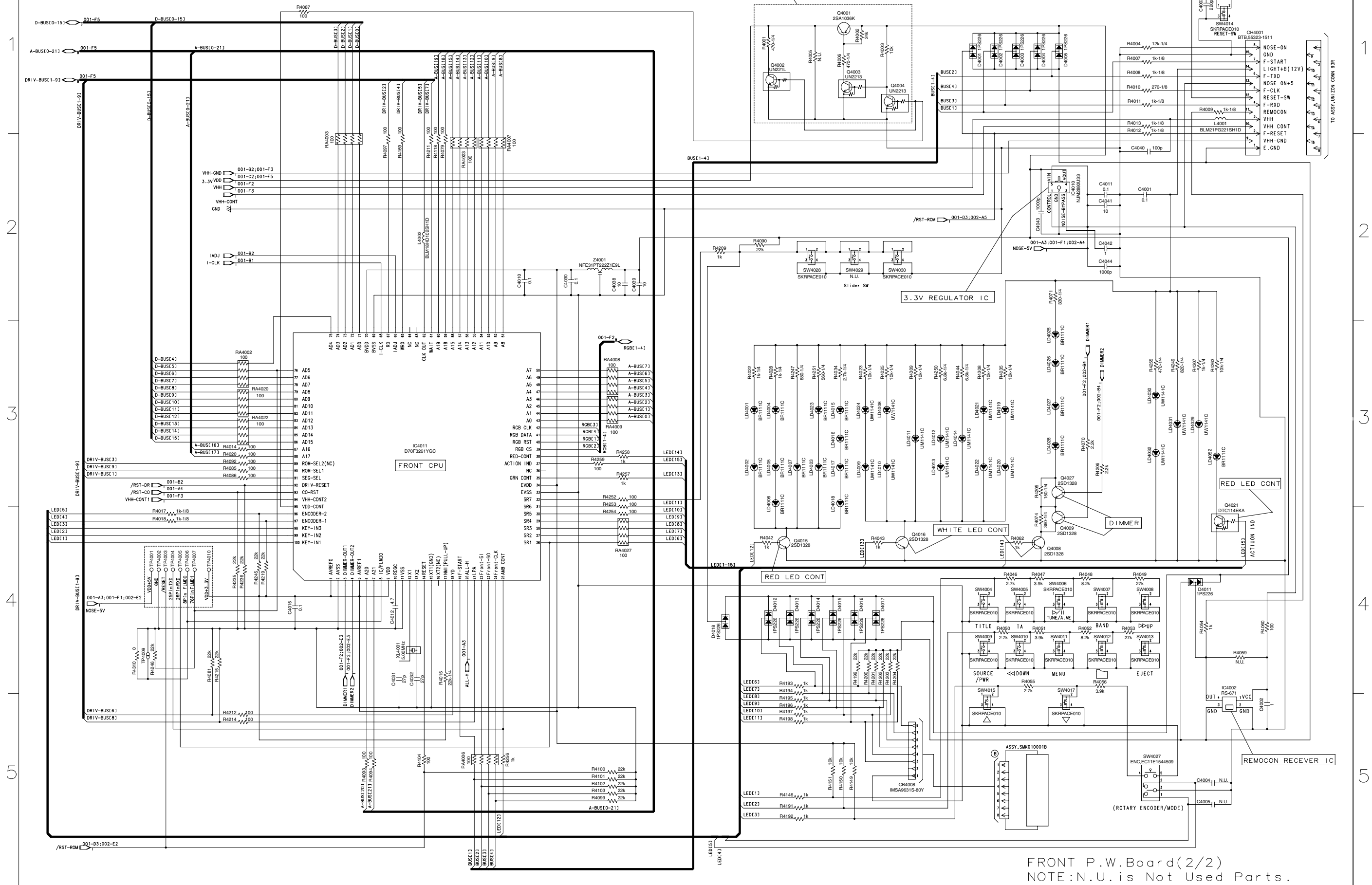

FRONT P.W. Board(2/2)
NOTE:N.U. is Not Used Parts.

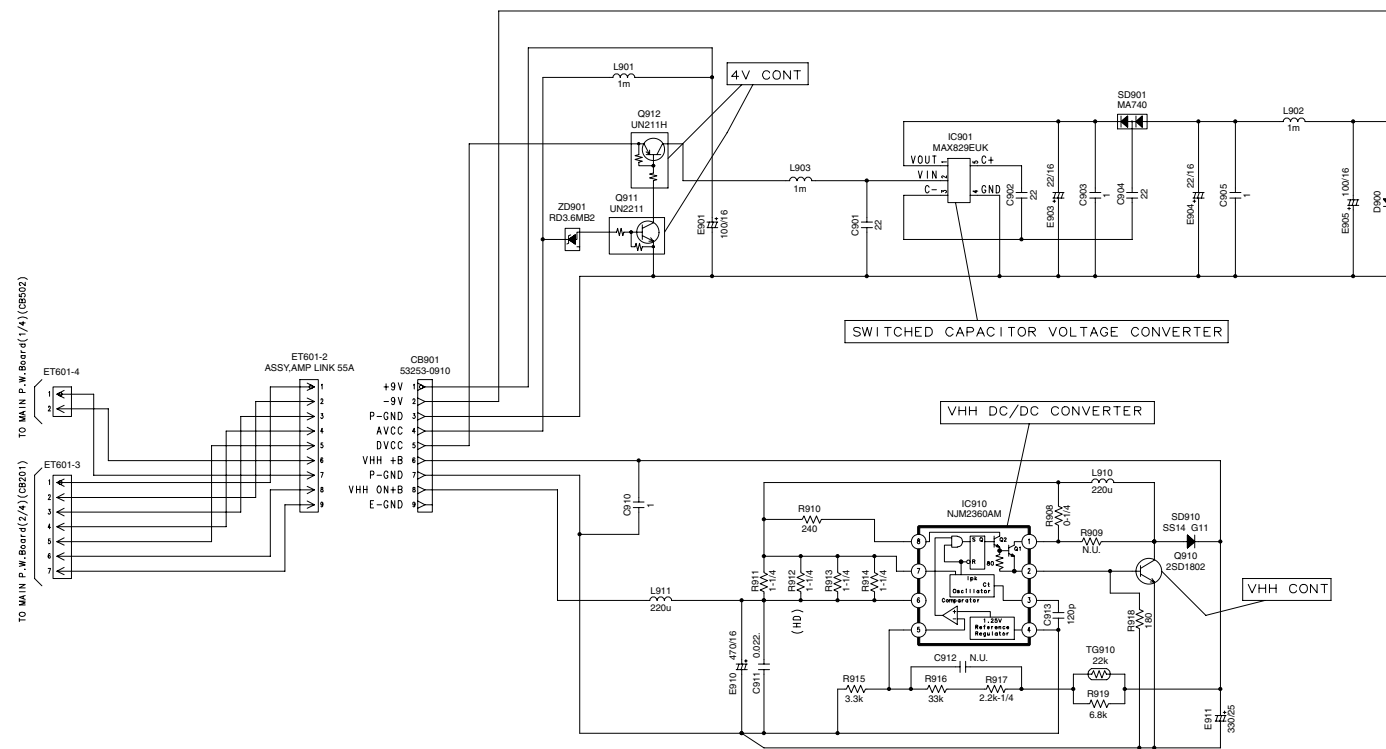

BOX P.W.Board
NOTE:N.U.is Not Used Parts.

Schematic Diagram(8/9)

CDA-9855R

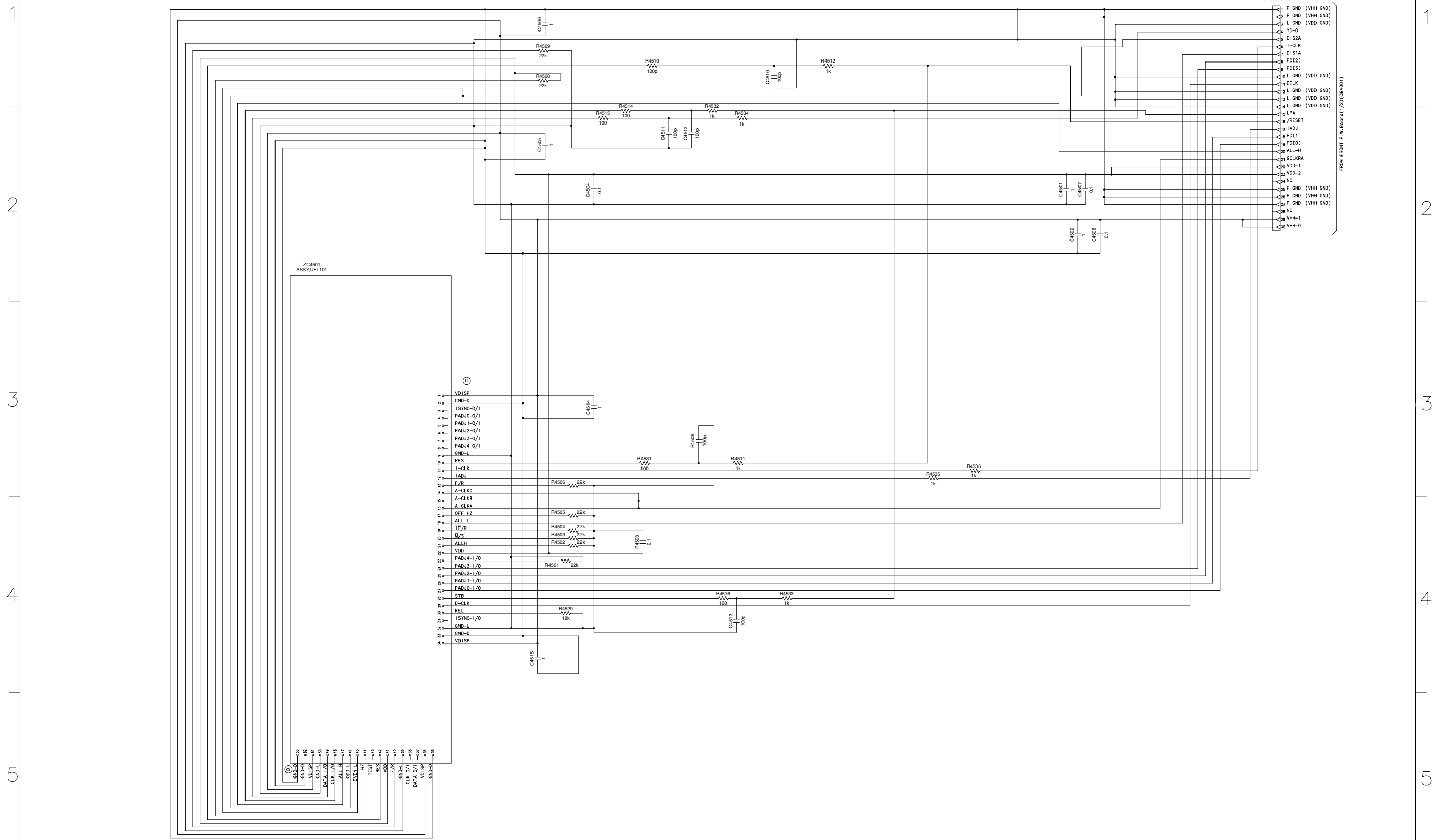

- 1 P.GND (VHH GND)
- 2 P.GND (VHH GND)
- 3 L.GND (VDD GND)
- 4 YD-0
- 5 D152A
- 6 I-CLK
- 7 D151A
- 8 PDI23
- 9 PDI23
- 10 L.GND (VDD GND)
- 11 DCLK
- 12 L.GND (VDD GND)
- 13 L.GND (VDD GND)
- 14 L.GND (VDD GND)
- 15 LPA
- 16 /RESET
- 17 IADJ
- 18 PDI13
- 19 PDI03
- 20 ALL-H
- 21 DCLKRA
- 22 VDD-1
- 23 VDD-2
- 24 NC
- 25 P.GND (VHH GND)
- 26 P.GND (VHH GND)
- 27 P.GND (VHH GND)
- 28 NC
- 29 VHH-1
- 30 VHH-0

FROM FRONT P.W.Board(1/2)(CB4001)

OELD P.W.Board

Schematic Diagram(9/9)

CDA-9855R

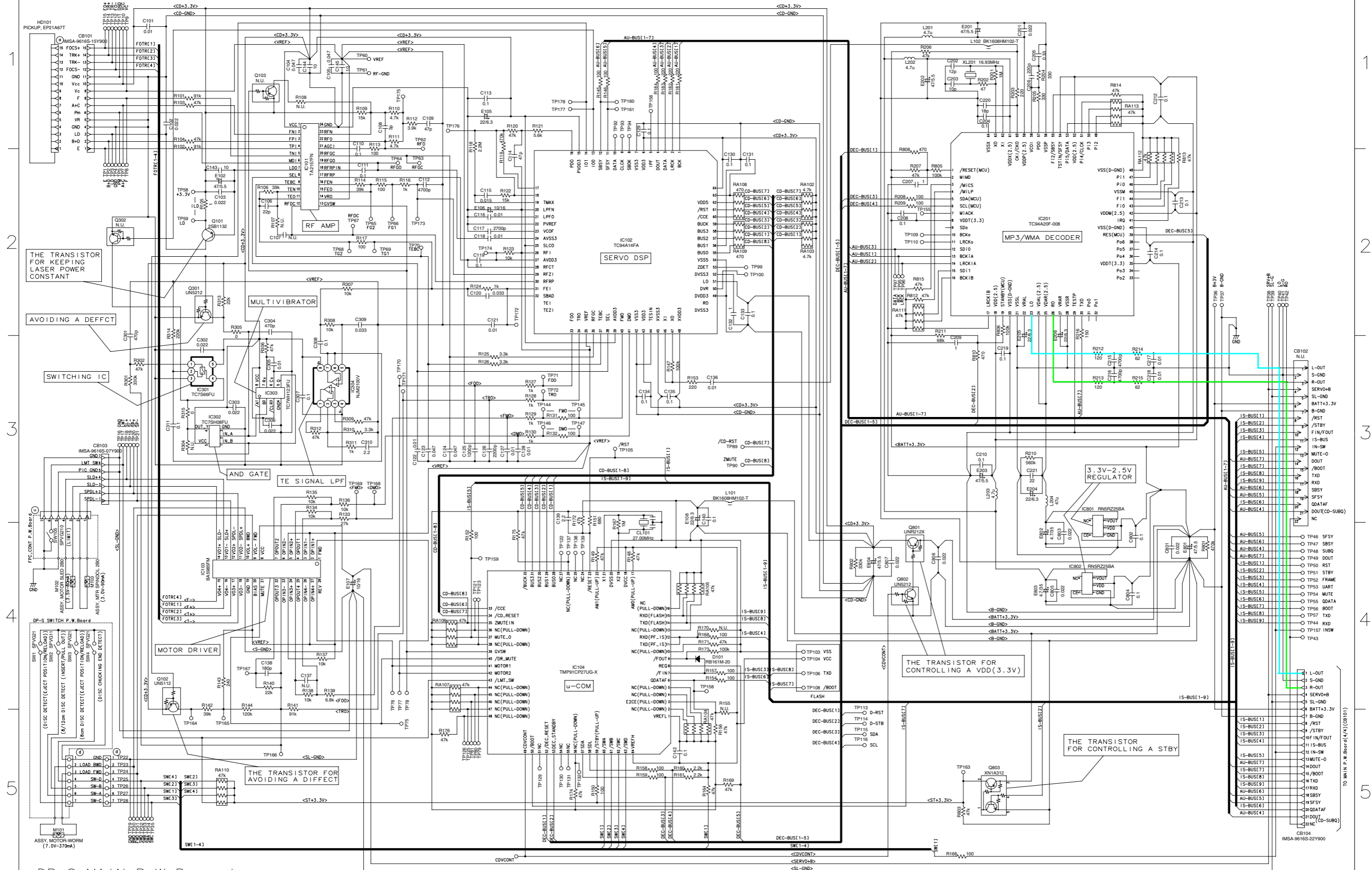

DP-S MAIN P.W. Board
 NOTE: N.U. is Not Used Parts.

TO MAIN P.W. Board (V1/CD10)

Terminal Voltage of IC/TR

IC001		
No.	Voltage	Note
1	3.16	
2	3.11	
3	0	
4	4.96	
5	4.96	

IC002								
No.	Voltage	Note	No.	Voltage	Note	No.	Voltage	Note
1	PS		8	5.04		15	0	
2	PS		9	PS		16	2.53	
3	0		10	PS		17	2.53	
4	2.55		11	NC		18	2.53	
5	2.17		12	0		19	2.53	
6	0		13	2.53		20	2.53	
7	5.05		14	5.05				

IC101		
No.	Voltage	Note
1	3.31	
2	6.57	
3	0	

IC201		
No.	Voltage	Note
1	3.3	
2	7.49	
3	0	

IC202								
No.	Voltage	Note	No.	Voltage	Note	No.	Voltage	Note
1	1.58		23	0		45	0	
2	3.28		24	0		46	0	
3	3.28		25	0		47	0	
4	1.63		26	0		48	3.28	
5	0		27	0		49	0	
6	1.63		28	NC		50	3.28	
7	3.28		29	NC		51	3.28/0	RESET OFF/ON
8	1.63		30	NC		52	3.28	
9	0		31	NC		53	0	
10	1.63		32	NC		54	0	
11	0		33	NC		55	0	
12	1.63		34	NC		56	0	
13	3.28		35	NC		57	1.63	
14	1.64		36	NC		58	1.63	
15	0		37	0		59	3.28	
16	1.63		38	3.28		60	1.63	
17	3.28		39	0		61	1.63	
18	3.28		40	0		62	0	
19	0		41	0		63	0	
20	0		42	PS		64	1.5	
21	0		43	PS				
22	0		44	NC				

IC204								
No.	Voltage	Note	No.	Voltage	Note	No.	Voltage	Note
1	NC		16	4.6		31	4.24	
2	NC		17	NC		32	4.24	
3	4.24		18	3.55		33	4.24	
4	4.24		19	0		34	4.24	
5	4.24		20	PS		35	4.24	
6	4.24		21	PS		36	4.24	
7	4.24		22	8.5		37	4.24	
8	4.24		23	NC		38	4.24	
9	4.24		24	NC		39	4.24	
10	4.24		25	4.24		40	4.24	
11	4.24		26	4.24		41	NC	
12	4.24		27	4.24		42	NC	
13	4.24		28	4.24		43	NC	
14	3.7		29	4.24		44	NC	
15	PS		30	4.24				

IC301								
No.	Voltage	Note	No.	Voltage	Note	No.	Voltage	Note
1	4.26		6	4.26		11	0	
2	4.26		7	4.26		12	4.26	
3	4.26		8	4.26		13	4.26	
4	8.55		9	4.26		14	4.26	
5	4.26		10	4.26				

IC302		
No.	Voltage	Note
1	4.26	
2	4.26	
3	4.26	
4	0	
5	PS	
6	PS	
7	PS	
8	8.56	

IC305		
No.	Voltage	Note
1	0	
2	0	
3	0	
4	-8.1	
5	0	
6	0	
7	0	
8	8.55	

IC306								
No.	Voltage	Note	No.	Voltage	Note	No.	Voltage	Note
1	0		6	0		11	-8.1	
2	0		7	0		12	0	
3	0		8	0		13	0	
4	8.55		9	0		14	0	
5	0		10	0				

IC307								
No.	Voltage	Note	No.	Voltage	Note	No.	Voltage	Note
1	0		10	7.9		19	7.62	
2	0		11	1.72		20	14.3	
3	7.62		12	1.6		21	7.62	
4	4.85		13	0		22	0	
5	7.62		14	1.63		23	7.62	
6	14.3		15	1.47		24	0	
7	7.62		16	1.33		25	3.59	
8	0		17	7.62				
9	7.62		18	0				

IC501								
No.	Voltage	Note	No.	Voltage	Note	No.	Voltage	Note
1	3.33		35	3.33		69	0	
2	0		36	4.95		70	3.33	
3	PS		37	3.33	CD	71	NC	
4	PS		38	0/3.33	TUNER/CD	72	3.33/0	NOSE CLOSE/OPEN
5	3.33		39	PS		73	3.33	
6	3.33		40	PS		74	0/3.27	CD
7	3.33		41	PS		75	0/3.33	2WAY/3WAY
8	0		42	PS		76	0	
9	3.33		43	PS		77	0/3.33	NOSE CLOSE/OPEN
10	2.55		44	PS		78	3.33	
11	0		45	0/3.33	BUZZER OFF/ON	79	3.33	
12	1.17		46	PS		80	0/3.33	FAN OFF/ON
13	1.21		47	PS		81	0/3.33	CD/TUNER
14	3.33/0	RESET OFF/ON	48	PS		82	3.33	
15	NC		49	3.33		83	3.33	
16	NC		50	PS		84	0/3.33	IF MUTE OFF/ON
17	3.33		51	PS		85	0/3.33	RDS CONT OFF/ON
18	4.94		52	PS		86	0/3.33	BW CONT OFF/ON
19	4.91		53	PS		87	0/3.33	DOOR LED OFF/ON
20	0/3.27	TUNER/CD	54	PS		88	0/3.33	MOTOR OFF/ON
21	PS		55	PS		89	0/3.33	BL-LED OFF/ON
22	PS		56	PS		90	2.9	
23	PS		57	PS		91	0/3.33	ADJCH OFF/ON
24	PS		58	PS		92	0/3.00	FM/AM
25	PS		59	3.33		93	2.88	HI-TEMP
26	PS		60	3.33		94	0/3.33	DISC IN
27	3.33/PS		61	0/3.17	DIMMER ON/OFF	95	0/3.33	POWER ON/OFF
28	3.33		62	3.33/0	POW IC ON/OFF	96	PS	
29	4.94/0	REMOCON OFF/ON	63	3.33		97	1.76	
30	3.33		64	3.33/0	FM/AM	98	2.5	
31	4.9		65	0/3.33	A MUTE ON/OFF	99	3.13	
32	3.33		66	3.33/0	INT ON/OFF	100	1.64	
33	0		67	3.33				
34	3.33		68	NC				

IC502		
No.	Voltage	Note
1	4.96	
2	3.34	
3	0	

IC503		
No.	Voltage	Note
1	0	
2	0	
3	4.95	
4	0	
5	PS	
6	PS	
7	0	
8	4.95	

IC504		
No.	Voltage	Note
1	8.68	
2	0	
3	4.95	

IC505		
No.	Voltage	Note
1	PS	
2	PS	
3	0	
4	PS	
5	4.95	

IC507								
No.	Voltage	Note	No.	Voltage	Note	No.	Voltage	Note
1	3.33/0	POW IC ON/OFF	6	0		11	PS	
2	4.9/0		7	0		12	PS	
3	3.33		8	PS		13	PS	
4	4.9		9	PS		14	4.9	
5	0		10	PS				

IC508					
No.	Voltage	Note	No.	Voltage	Note
1	0/3.33	RESET ON/OFF	4	NC	
2	1.27/3.33	RESET ON/OFF	5	1.77/0	RESET ON/OFF
3	0				

IC510								
No.	Voltage	Note	No.	Voltage	Note	No.	Voltage	Note
1	PS		7	PS		13	PS	
2	PS		8	0		14	0	
3	PS		9	4.9		15	4.9	
4	PS		10	0		16	4.9	
5	1.83		11	4.9				
6	2.2		12	PS				

IC601		
No.	Voltage	Note
1	4.95	
2	PS	
3	0	
4	PS	
5	4.95	

IC602		
No.	Voltage	Note
1	4.95	
2	PS	
3	0	
4	PS	
5	4.95	

CDA-9855R

IC604		
No.	Voltage	Note
1	PS	
2	PS	
3	PS	
4	0	
5	PS	
6	4.95	
7	PS	
8	4.95	

IC605		
No.	Voltage	Note
1	0	
2	PS	
3	PS	
4	0	
5	0	
6	PS	
7	PS	
8	4.95	

IC802								
No.	Voltage	Note	No.	Voltage	Note	No.	Voltage	Note
1	NC		10	12.43		19	0	
2	0/5.97	ANGLE action	11	12.43		20	0	
3	NC		12	NC		21	0	
4	0/4.4	ANGLE action	13	0		22	NC	
5	NC		14	NC		23	NC	
6	0/4.4	ANGLE action	15	0/4.7	ANGLE action	24	0/4.7	ANGLE action
7	0		16	NC		25	NC	
8	0/4.4	ANGLE action	17	NC				
9	NC		18	NC				

IC803								
No.	Voltage	Note	No.	Voltage	Note	No.	Voltage	Note
1	NC		6	5.15		11	2.44	
2	13.7		7	4.9		12	7.06/0	CD/TUNER
3	4.43		8	14.4		13	1.33	
4	5.7		9	1.8		14	10.14	
5	5.04		10	8.56		15	0	

IC804								
No.	Voltage	Note	No.	Voltage	Note	No.	Voltage	Note
1	0		6	PS		11	0	
2	0		7	0		12	PS	
3	PS		8	PS		13	PS	
4	PS		9	PS		14	4.9	
5	PS		10	0				

IC901		
No.	Voltage	Note
1	-4.23	
2	4.74	
3	-2.06	
4	0	
5	2.46	

IC910		
No.	Voltage	Note
1	10.12	
2	PS	
3	0.9	
4	0	
5	1.29	
6	10.14	
7	10.12	
8	10.03	

IC4001								
No.	Voltage	Note	No.	Voltage	Note	No.	Voltage	Note
1	5.02		6	1.9		9	3.04/0.09/ 2.63/3.18	BLUE/GRN/ AMB/RED
2	PS		7	0				
3	PS		8	0.08/2.79/ 2.72/2.92	BLUE/GRN/ AMB/RED	10	3.55/3.47/ 0.27/3.72	BLUE/GRN/ AMB/RED
4	PS							
5	PS							

IC4002		
No.	Voltage	Note
1	4.86	
2	0	
3	0	
4	3.75	

IC4005								
No.	Voltage	Note	No.	Voltage	Note	No.	Voltage	Note
1	PS		17	PS		33	PS	
2	PS		18	PS		34	PS	
3	PS		19	PS		35	PS	
4	PS		20	PS		36	PS	
5	PS		21	PS		37	3.31	
6	PS		22	PS		38	PS	
7	PS		23	PS		39	PS	
8	PS		24	PS		40	PS	
9	PS		25	PS		41	PS	
10	PS		26	0		42	PS	
11	3.29		27	0		43	PS	
12	3.01		28	3.28		44	PS	
13	0		29	PS		45	PS	
14	0		30	PS		46	0	
15	PS		31	PS		47	3.31	
16	PS		32	PS		48	PS	

IC4008-1								
No.	Voltage	Note	No.	Voltage	Note	No.	Voltage	Note
1	3.3		17	3.31		33	3.31	
2	3.31		18	PS		34	3.31	
3	PS		19	NC		35	PS	
4	0		20	NC		36	0	
5	0		21	NC		37	0	
6	0		22	NC		38	0.01	
7	NC		23	NC		39	0	
8	PS		24	NC		40	PS	
9	NC		25	NC		41	3.28	
10	PS		26	NC		42	3.28	
11	NC		27	NC		43	0	
12	PS		28	NC		44	0	
13	PS		29	3.3		45	PS	
14	PS		30	0		46	PS	
15	PS		31	0		47	PS	
16	1.82		32	1.82		48	1.82	

IC4008-2								
No.	Voltage	Note	No.	Voltage	Note	No.	Voltage	Note
49	3.31		55	PS		61	PS	
50	PS		56	0		62	PS	
51	PS		57	PS		63	PS	
52	PS		58	PS		64	1.82	
53	PS		59	PS				
54	PS		60	PS				

IC4010		
No.	Voltage	Note
1	5.02	
2	0	
3	1.26	
4	3.33	
5	5.02	

IC4012		
No.	Voltage	Note
1	4.74	
2	0.02	
3	1.3	
4	1.82	
5	5.01	

IC4011								
No.	Voltage	Note	No.	Voltage	Note	No.	Voltage	Note
1	3.36		36	NC		71	PS	
2	0		37	3.36		72	PS	
3	3.36/0/0	DIM1/2/3	38	3.36/0	RED LED ON	73	PS	
4	0/3.36/0	DIM1/2/3	39	PS		74	PS	
5	3.36		40	PS		75	PS	
6	PS		41	PS		76	PS	
7	PS		42	PS		77	PS	
8	0		43	PS		78	PS	
9	3.36		44	PS		79	PS	
10	2.63		45	PS		80	PS	
11	0		46	PS		81	PS	
12	1.12		47	PS		82	PS	
13	1.23		48	PS		83	PS	
14	3.06		49	PS		84	PS	
15	0		50	PS		85	PS	
16	2.51		51	PS		86	PS	
17	3.33		52	PS		87	PS	
18	PS		53	PS		88	PS	
19	PS		54	PS		89	3.36	
20	0		55	PS		90	0	
21	PS		56	PS		91	PS	
22	PS		57	PS		92	PS	
23	PS		58	PS		93	PS	
24	PS		59	PS		94	3.36	
25	3.36/0	AMB LED ON	60	PS		95	0	
26	3.36/0	SLIDER OFF/ON	61	PS		96	PS	
27	3.36/0	SLIDER OFF/ON	62	PS		97	PS	
28	3.36/0	SLIDER OFF/ON	63	NC		98	0/0.77/ 1.36/3.36	KEY ON
29	3.36/0	SLIDER OFF/ON	64	NC		99	0/0.77/ 1.36/2.05/ 2.76/3.36	KEY ON
30	3.36/0	SLIDER OFF/ON	65	PS		100	0/0.77/ 1.36/2.05/ 2.76/3.36	KEY ON
31	3.36/0	SLIDER OFF/ON	66	PS				
32	3.36/0	SLIDER OFF/ON	67	PS				
33	0		68	PS				
34	3.36		69	0				
35	3.36/0	GRN LED ON	70	3.36				

Ref.	B	C	E	Note
Q002	3.28	0	0	ADJCH MUTE
Q003	7.78	8.48	8.55	AM
Q004	0	8.49	8.55	FM
Q005	3.29/0	0/8.54	0/0	FM/AM
Q201	3.28	0	0	IF MUTE
Q387	0/3.28	4.38/0	0/0	MUTE ON/OFF
Q389	4.35/0	0/4.16	0/0	MUTE ON/OFF
Q502	9.35	14.27	8.75	NOSE +5V
Q503	9.35	14.27	8.75	NOSE +5V
Q508	4.38	4.96	5	REMOCON
Q509	2.54	0	0	REMOCON
Q517	0/3.3	3.25/0	3.3/3.3	RESET ON/OFF
Q601	3.2	0	0	DOOR LED
Q801	3.29/0	0/4.79	0/0	TUNER/CD
Q808	1.2/0	0.37/1.75	0/0	High Volt DET
Q809	2.92/4.9	4.66/0	4.67/4.9	IN INT ON/OFF
Q810	10.7	14.4	10.1	VHH CONT
Q811	10.7	14.4	10.1	VHH CONT
Q812	8.11	13.93	7.49	DSP+B
Q813	8.11	13.93	7.49	DSP+B
Q814	12.72	14.56	12.1	LIGHT +12V
Q817	9.68/0	0/3.17	0/0	DIMMER ON/OFF
Q818	12/0	14.4/14.4	11.39/0	FAN ON/OFF
Q821	12.9	14.1	12.4	MOTOR +B
Q827	0.4/0	11.42/13.99	0/0	BUZZER ON/OFF
Q910	PS	10.1	0	VHH CONT
Q911	5.79	0	0	4V CONT
Q912	0	4.8	4.9	4V CONT
Q4001	2.58	3.31	3.31	VDD CONT
Q4002	0	3.31	0	VDD CONT
Q4003	1.97	0.1	0	VDD CONT
Q4004	0	1.97	0	VDD CONT
Q4008	0	6.54	0	WHITE LED CONT
Q4009	3.31	6.55	6.55	DIMMER 1
	0	6.56	6.56	DIMMER 2
	0	6.56	6.56	DIMMER 3
Q4015	0	9.49	0	RED LED CONT
Q4016	0.71	0	0	WHITE LED CONT
Q4017	16.54	17.24	17.23	VHH CONT
Q4018	17.1	0	0	VHH CONT
Q4019	0.73	0.03	0.11	VHH CONT
Q4020	0	2.24	0	VHH CONT
Q4021	3.26	0	0	RED LED CONT
Q4027	0	6.55	6.55	DIMMER 1
	3.31	6.56	6.56	DIMMER 2
	0	6.56	6.56	DIMMER 3

Ref.	1	2	3	4	5	Note
Q101	0	3.29	3.3	3.27	0	CD STBY
Q388	0/14.4	14.4/0	14.4/14.4	4.38/0	0/0	MUTE ON/OFF
Q501	0	14.4	14.4	3.29	0	NOSE POWER
Q504	0	3.31	3.31	3.31	0	VDD PULLUP
Q516	0/4.87	4.84/1.95	4.93/4.87	3.27/0	0/0	RESET ON/OFF
Q802	5.03/0	0/4.88	5.04/0	0.3/1.75	0/0	High Volt DET
Q803	0	4.69	4.74	4.7	0	ACC+5V
Q807	0	4.7	4.72	4.94	0	ACC DET
Q815	0	14.4	14.4	3.29	0	LIGHT +12V
Q816	0	14.4	14.4	3.3	0	VHH CONT
Q819	0/13.96	13.87/0	13.89/13.99	3.28/0	0/0	FAN ON/OFF
Q822	0	14.06	14.09	3.03	0	MOTOR +B
Q823	0	4.88	4.89	3.3	0	TUNER/CD
Q824	0	12.35	12.35	3.15	0	MOTOR REV
Q825	0	12.28	12.42	3.03	0	MOTOR FOR
Q826	0	14.11	14.15	3.2	0	DSP+B
Q4028	4.47	4.96	0	0	4.95	DIMMER 1
	4.05	4.12	4.81	0	0	DIMMER 2
	3.92	4.27	0	4.26	0	DIMMER 3
Q4029	4.96	5.02	4.84	0	0	DIMMER 1
	4.12	5.02	0	4.96	0	DIMMER 2
	4.27	5.02	0	5	0	DIMMER 3

Ref.	1	2	3	4	5	6
Q302	0/0	0/0	0/0	6.53/0	0/0	6.53/0
	MUTE ON/OFF					
Q303	0/0	0/0	0/0	6.53/0	0/0	6.53/0
	MUTE ON/OFF					
Q304	0/0	0/0	0/0	6.53/0	0/0	6.53/0
	MUTE ON/OFF					
Q602	4.7	5	4.5	4.6	5	4.5
	OEM SUB-DISPLAY					

[Measuring Conditions]

1. Power Supply Voltage : DC14.4V
2. Measuring Meter : Digital Multimeter
3. Measuring Point Reference : Between GND
4. Measuring Condition : See each data
It measures in normal temperature.

(CD Deck Mechanism)

IC101					
	CD-DA PLAY	MP3 PLAY		CD-DA PLAY	MP3 PLAY
1	3.32V	3.28V	13	3.30V	3.03V
2	-	-	14	1.64V	1.66V
3	-	-	15	1.62V	1.66V
4	1.66V	1.68V	16	1.62V	1.66V
5	1.70V	1.68V	17	2.62V	2.26V
6	0.26V	0.24V	18	1.68V	1.66V
7	2.54V	2.52V	19	1.36V	1.34V
8	2.04V	2.02V	20	0.30V	0.64V
9	1.70V	1.72V	21	2.48V	2.36V
10	1.64V	1.64V	22	1.32V	1.12V
11	1.60V	1.64V	23	0.08V	1.70V
12	2.54V	2.02V	24	0.14V	0.08V

IC102					
	CD-DA PLAY	MP3 PLAY		CD-DA PLAY	MP3 PLAY
1	1.56V	1.66V	33	1.68V	1.62V
2	1.72V	1.68V	34	1.68V	1.62V
3	0.09V	0.10V-2.34V H/L	35	1.68V	1.64V
4	1.72V	1.66V	36	0.20V-1.20V H/L	0.38V-1.24V H/L
5	0.08V	0.10V-3.28V H/L	37	1.68V-2.56V H/L	1.68V-2.54V H/L
6	3.24V	3.24V	38	2.04V	2.08V
7	0.08V	0.10V	39	3.28V	3.22V
8	0.08V-3.24V H/L	0.08V-3.24V H/L	40	1.60V	1.16V-1.66V H/L
9	0.00V	0.00V	41	1.76V	1.66V-2.10V H/L
10	3.28V	3.24V	42	0.08V	0.10V
11	0.09V	0.10V	43	3.28V	3.24V
12	0.00V	0.00V	44	0.08V	0.10V
13	3.28V	0.10V-3.24V H/L	45	0.08V	0.10V
14	3.28V	3.24V	46	1.68V	1.66V
15	3.28V	3.24V	47	1.68V	1.66V
16	1.68V	1.68V	48	3.28V	3.22V
17	1.64V	1.60V	49	0.10V	0.10V
18	1.64V	1.66V	50	1.64V	1.66V
19	1.68V	1.66V	51	3.28V	3.22V
20	1.68V	1.66V	52	1.68V	1.64V
21	1.12V	1.10V	53	1.68V	1.66V
22	0.08V	0.10V	54	0.08V	0.10V
23	1.64V	1.66V	55	3.28V	0.10V-3.22V H/L
24	1.72V	1.68V	56	0.80V	0.10V
25	3.28V	3.22V	57	0.08V-3.28V H/L	0.10V-3.22V H/L
26	1.68V	1.66V	58	0.08V-3.28V H/L	0.10V-3.22V H/L
27	1.68V	1.68V	59	0.08V-3.28V H/L	0.10V-3.22V H/L
28	2.60V	2.34V	60	0.08V-3.28V H/L	0.10V-3.22V H/L
29	1.68V	1.64V	61	0.08V-3.28V H/L	0.10V-3.22V H/L
30	2.52V	2.00V	62	0.08V-3.28V H/L	0.10V-3.22V H/L
31	1.64V	1.58V	63	3.28V	3.24V
32	1.68V	1.64V	64	3.28V	3.24V

IC103					
	CD-DA PLAY	MP3 PLAY		CD-DA PLAY	MP3 PLAY
1	0.11V	0.10V	15	3.56V	3.50V
2	1.68V	1.66V	16	3.24V	3.24V
3	1.64V	1.66V	17	3.36V	3.35V
4	1.68V	1.66V	18	3.44V	3.44V
5	1.68V	1.66V	19	0.11V	0.10V
6	1.68V	1.66V	20	1.68V	1.64V
7	1.52V	1.52V	21	3.32V	3.30V
8	7.00V	7.00V	22	1.68V	1.62V
9	0.11V	0.10V	23	1.68V	1.64V
10	0.11V	0.10V	24	1.68V	1.64V
11	3.80V	3.80V	25	1.68V	1.64V
12	2.96V	3.00V	26	1.68V	1.64V
13	3.28V	3.26V	27	1.68V	1.64V
14	3.56V	3.50V	28	0.11V	0.10V

IC104					
	CD-DA PLAY	MP3 PLAY		CD-DA PLAY	MP3 PLAY
1	0.10V	0.10V	33	0.10V-3.26V H/L	0.12V-3.12V H/L
2	0.10V	0.10V	34	3.24V	3.22V
3	0.10V	0.10V	35	0.10V	0.08V-3.18V H/L
4	0.10V	0.10V	36	0.10V	0.10V
5	0.10V	0.10V	37	0.10V	0.10V
6	0.10V	0.10V	38	0.08V	0.10V
7	0.34V-3.30V H/L	0.36V-3.28V H/L	39	3.30V	3.28V
8	0.10V	0.06V-3.28V H/L	40	3.30V	3.28V
9	0.34V-3.30V H/L	0.28V-3.28V H/L	41	0.10V	0.10V
10	0.08V	0.10V	42	0.10V	0.10V
11	0.24V-3.30V H/L	0.30V-3.30V H/L	43	3.30V	3.30V
12	0.28V-3.30V H/L	0.30V-3.30V H/L	44	0.08V	0.08V
13	0.08V	0.10V	45	0.08V	0.08V
14	3.22V	3.20V	46	0.08V	0.08V
15	3.22V	3.20V	47	0.08V	0.08V
16	0.08V	0.08V	48	0.08V	0.08V
17	-	-	49	3.30V	3.28V
18	3.32V	1.68V	50	0.10V	0.10V
19	1.64V	3.30V	51	0.10V	0.08V
20	0.10V	0.00V	52	3.30V	3.30V
21	1.62V	3.02V	53	0.10V	0.14V
22	3.30V	3.28V	54	3.30V	3.30V
23	3.30V	3.28V	55	3.30V	3.30V
24	0.10V	0.10V	56	0.08V	0.08V
25	0.10V	0.10V	57	3.30V	0.28V-3.30V H/L
26	0.10V	0.10V	58	3.30V	0.28V-3.30V H/L
27	0.00V	0.00V	59	3.30V	3.30V
28	0.34V-3.28V H/L	0.38V-3.22V H/L	60	3.30V	3.30V
29	0.10V-3.26V H/L	0.12V-3.24V H/L	61	0.10V	0.08V
30	0.10V-3.26V H/L	0.12V-3.12V H/L	62	0.10V	0.08V
31	0.10V-3.26V H/L	0.12V-3.12V H/L	63	0.10V	0.08V
32	0.10V-3.26V H/L	0.12V-3.12V H/L	64	3.30V	3.30V

IC201					
	CD-DA PLAY	MP3 PLAY		CD-DA PLAY	MP3 PLAY
1	3.30V	3.28V	33	0.13V	0.10V
2	3.30V	3.28V	34	0.10V	0.10V
3	0.10V	0.10V	35	3.30V	3.28V
4	0.10V	0.10V	36	0.10V	0.10V
5	3.30V	0.42V-3.28V H/L	37	0.12V	0.10V
6	3.30V	0.40V-3.30V H/L	38	0.12V	0.10V
7	3.30V	3.28V	39	0.10V	0.10V-3.30V H/L
8	3.30V	3.28V	40	0.10V	0.10V
9	0.10V	0.10V	41	0.10V	0.10V
10	0.10V	0.10V	42	2.52V	2.50V
11	0.10V	0.10V	43	0.10V	0.10V
12	0.10V	0.10V-3.30V H/L	44	0.10V	0.10V
13	1.68V	0.00V-3.30V H/L	45	0.10V	0.10V
14	1.64V	0.08V-3.26V H/L	46	0.10V	0.10V
15	0.10V	0.10V	47	0.10V	0.10V
16	0.10V	0.10V	48	0.10V	0.10V
17	0.10V	0.10V	49	0.10V	0.10V
18	2.56V	2.54V	50	0.10V	0.10V
19	0.12V	0.10V	51	0.10V	0.10V
20	0.10V	0.10V	52	2.56V	2.52V
21	0.10V	0.10V	53	0.10V	0.10V
22	1.34V	1.32V	54	2.56V	2.52V
23	1.34V	1.32V	55	0.10V	0.10V
24	2.58V	2.58V	56	0.10V	0.10V
25	2.58V	2.58V	57	1.40V	1.42V
26	1.34V	1.36V	58	1.40V	1.42V
27	1.32V	1.36V	59	2.56V	2.56V
28	0.10V	0.10V	60	1.66V	1.66V
29	0.10V	0.10V	61	2.56V	2.60V
30	1.88V	0.00V-3.30V H/L	62	1.16V	1.20V
31	0.10V	0.10V	63	1.28V	1.20V
32	0.13V	0.10V	64	0.10V	0.10V

IC301		
	CD-DA PLAY	MP3 PLAY
1	1.54V	1.54V
2	1.56V	1.56V
3	0.00V	0.00V
4	0.00V	0.00V
5	3.17V	3.17V

← PULSE : 2.76V (when disc scratch is detected)

IC302		
	CD-DA PLAY	MP3 PLAY
1	0.00V	0.00V
2	0.00V	0.00V
3	0.00V	0.00V
4	0.00V	0.00V
5	3.17V	3.17V

← PULSE : 3.18V (when disc scratch is detected)

← PULSE : 2.95V (when disc scratch is detected)

← PULSE : 2.76V (when disc scratch is detected)

IC303		
	CD-DA PLAY	MP3 PLAY
1	0.00V	0.00V
2	0.00V	0.00V
3	3.17V	3.17V
4	0.00V	0.00V
5	0.00V	0.00V
6	0.00V	0.00V
7	3.17V	3.17V
8	3.17V	3.17V

← PULSE : 3.17V (when disc scratch is detected)

← PULSE : 3.17V (when disc scratch is detected)

IC304		
	CD-DA PLAY	MP3 PLAY
1	1.65V	1.65V
2	1.60V	1.60V
3	1.59V	1.59V
4	0.00V	0.00V
5	1.56V	1.56V
6	1.56V	1.56V
7	1.56V	1.56V
8	3.17V	3.17V

IC801		
	CD-DA PLAY	MP3 PLAY
1	0.10V	0.10V
2	3.30V	3.30V
3	2.56V	2.56V
4	0.00V	0.00V
5	3.30V	3.30V

IC802		
	CD-DA PLAY	MP3 PLAY
1	0.10V	0.10V
2	3.30V	3.30V
3	2.56V	2.56V
4	0.00V	0.00V
5	3.30V	3.30V

Q101		
	CD-DA PLAY	MP3 PLAY
B	2.54V	2.56V
C	2.24V	2.26V
E	3.20V	3.18V

Q102		
	CD-DA PLAY	MP3 PLAY
B	3.20V	3.22V
C	1.66V	1.66V
E	3.24V	3.22V

Q301		
	CD-DA PLAY	MP3 PLAY
B	0.00V	0.00V
C	0.00V	0.00V
E	3.17V	3.17V

← PULSE : 3.17V (when disc scratch is detected)

Q801		
	CD-DA PLAY	MP3 PLAY
B	0.16V	0.20V
C	3.22V	3.24V
E	3.22V	3.32V

Q802		
	CD-DA PLAY	MP3 PLAY
B	3.30V	3.30V
C	0.16V	0.18V
E	0.16V	0.12V

Q803		
	CD-DA PLAY	MP3 PLAY
1	0.10V	0.10V
2	3.30V	3.28V
3	3.30V	3.28V
4	5.08V	5.06V
5	0.10V	0.10V

[Measuring Conditions]

1. Power Supply Voltage : DC12.2V
2. Measuring Meter : Digital Multimeter / Oscilloscope
3. Measuring Point Reference : Between GND
4. Measuring Condition : (1) It measures in normal temperature with JIG.
(power supply voltage 12V)
(2) Two kinds are measured.
at playing CD-DA (TCD-782) and MP3 (SCD-5100)
(3) It measures in both sides of Analog and Digital.

Description of IC Terminal

D70F3263YGC : IC501

No.	Symbol	I/O	Terminal Description
1	AVref1	-	AVref power supply input terminal. (connect to VDD)
2	AVss	-	GND connect terminal for A/D Converter.
3	DSP CLK	O	DSP CLOCK output terminal.
4	DSP DATA	I/O	DSP DATA output terminal.
5	AVref2	-	AVref power supply input terminal. (connect to VDD)
6	MOTOR FOR	O	Swing Mech FOR control terminal.
7	MOTOR REV	O	Swing Mech REV control terminal.
8	FLMD0	-	FLMD0 input terminal.
9	VDD	-	VDD connect terminal.
10	REGC	-	Capacitor connect terminal. (4.7uF connect)
11	Vss	-	GND connect terminal.
12	MAIN XIN	I	Crystal connect terminal for main system clock OSC.
13	MAIN XOUT	O	
14	RESET	I	System Reset input terminal.
15	NC(GND)	-	GND connect terminal.
16	NC	-	No connect terminal.
17	NMI(PULL-UP)	-	Pull-up connect terminal.
18	BATT DET	I	BATT ON detection signal input terminal.
19	ACC DET	I	ACC ON detection signal input terminal.
20	CD F IN	I	FRAME data input terminal from CD Mech.
21	AiBUS IRQ	I	AI-NET BUS IRQ signal input terminal.
22	EVOL DATA	O	E-VOL and EEPROM DATA output terminal.
23	EVOL CLK	O	E-VOL and EEPROM CLK signal output terminal.
24	TUNER CLK	O	TUNER CLK output terminal.
25	AiBUS OUT	O	AI-NET BUS signal output terminal.
26	AiBUS IN	I	AI-NET BUS signal input terminal.
27	AiBUS SCLK	O	AI-NET BUS SCLK signal output terminal.
28	AiBUS RS	O	AI-NET BUS R/S signal output terminal.
29	REMOCON	I	Remote control signal input terminal.
30	AiBUS R/W	O	AI-NET BUS R/W signal output terminal.
31	AiBUS IRQ	O	AI-NET BUS IRQ signal output terminal.
32	AiBUS RST	O	AI-NET BUS RESET signal output terminal.
33	EVss	-	GND connect terminal.
34	EVDD	-	VDD connect terminal.
35	RDSMON TX	O	Command output terminal to RDS monitor.
36	RDSMON RX	I	Status input terminal from RDS monitor.
37	CD RST	O	RESET signal output terminal to CD Mech.
38	CD STBY	O	STBY signal output terminal to CD Mech.
39	TUNER DATA	I/O	TUNER DATA input / output terminal.
40	CD SFSY	I	CD TEXT DATA input terminal.
41	CD FOUT	O	FRAME signal output terminal to CD Mech.
42	CD SBSY	O	CD TEXT DATA output terminal.
43	CD TXD	O	Data output terminal to CD Mech.
44	CD RXD	I	Data input terminal from CD Mech.
45	BUZZER	O	Buzzer signal output terminal.
46	RDS CLK	O	RDS CLK output terminal.
47	RDS DATA	I/O	RDS DATA input / output terminal.

No.	Symbol	I/O	Terminal Description
48	F-START	O	Front u-COM communication start output terminal.
49	F-RESET	O	Front u-COM RESET signal output terminal.
50	AMP DATA IN	I	AMP LINK DATA input terminal.
51	AMP DATA OUT	O	AMP LINK DATA output terminal.
52	AMP CLK	O	AMP LINK CLOCK output terminal.
53	F-IN	I	Data signal input terminal from Front u-COM.
54	F-OUT	O	Data signal output terminal to Front u-COM.
55	F-CLK	I	Clock signal input terminal from Front u-COM.
56	CD QDATAF	I	CD QDATA input terminal.
57	OEM SUB DATA	O	OEM SUB DISPLAY DATA output terminal.
58	OEM SUB CLK	O	OEM SUB DISPLAY CLK output terminal.
59	NOSE POWER	O	NOSE POWER control output terminal.
60	AUTO ADJ	I	TUNER auto adjustment input terminal.
61	IN DIMMER	I	DIMMER signal input terminal.
62	PWR IC ON	O	POWER IC control output terminal.
63	O-REM	O	OUT-REM signal output terminal.
64	FM/AM	O	TUNER power supply control signal output terminal. (Hi : FM, Lo : AM)
65	A.MUTE	O	A-MUTE output terminal.
66	ININT	I	IN INT input terminal.
67	DSP RESET	O	DSP RESET output terminal.
68	ARIA1(NC)	-	No connect terminal.
69	BVSS	-	GND connect terminal.
70	BVDD	-	VDD connect terminal.
71	NC	-	No connect terminal.
72	LIMIT SW1	I	Swing Mech SW1 input terminal.
73	VDD PULLUP	O	Pull-up resistor power supply control output terminal.
74	ZERO-DET	I	ZERO DET signal input terminal.
75	2WAY/3WAY	I	2WAY / 3WAY switching input terminal.
76	FLMD1(NC)	-	No connect terminal.
77	LIMIT SW2	I	Swing Mech SW2 input terminal.
78	V-CONT(NC)	-	No connect terminal.
79	P-ANT(NC)		
80	FAN CONT	O	FAN CONT output terminal.
81	CONT2	O	Power supply IC control terminal.
82	CONT1		
83	P-CONT	O	POWER CONTROL output terminal.
84	IF MUTE	O	IF MUTE output terminal.
85	RDS CONT	O	RDS control output terminal.
86	BW CONT(NC)	-	No connect terminal.
87	DOOR LED	O	DOOR LED control terminal.
88	MOTOR ON	O	MOTOR power supply control terminal.
89	BL-LED	O	Backlight LED power supply control terminal.
90	DAVN	I	DAVN input terminal.
91	ADJCH DET	I	ADJCH detection input terminal.
92	AM SD	I	TUNER Seek Stop signal input terminal.
93	HI-TEMP	I	CD HI-TEMP signal input terminal.
94	DISC IN	I	CD DISC-IN detection signal input terminal.
95	VHH CONT	O	VHH CONT output terminal.

No.	Symbol	I/O	Terminal Description
96	MP	I	Multi-Path signal input terminal.
97	AFC	I	AFC signal input terminal.
98	SSTOP	I	SEEK STOP input terminal.
99	S/M	I	TUNER S/M level input terminal.
100	NOSE DET	I	NOSE installation detect terminal.

D70F3261YGC : IC4011

No.	Symbol	I/O	Terminal Description
1	AVREF0	-	Reference voltage input terminal for A/D Converter.
2	AVSS	-	GND terminal for A/D Converter.
3	DIMMER-OUT1	O	DIMMER level control output terminal.
4	DIMMER-OUT2		
5	AVREF1	-	Power supply terminal for A/D Converter.
6	A20	-	External ROM address port terminal.
7	A21		
8	IC/FLMD0	I	Vdd connect terminal.
9	VDD	-	Power supply terminal for Clock.
10	REGC	-	Capacitor connect terminal for Regulator.
11	VSS	-	GND terminal for Clock.
12	X1	-	Crystal connect terminal. (5MHz)
13	X2		
14	RESET	I	System reset input terminal.
15	XT1(GND)	-	GND connect terminal.
16	XT2(NC)	-	No connect terminal.
17	NMI(PULL-UP)	I	Non-maskable interruption request input terminal. (Pull-up)
18	YD	I	OELD frame signal taking-in interruption input terminal.
19	F-START	I	Communication frame interruption input terminal from Main u-COM.
20	ALL-H	O	OELD display control output terminal.
21	LPA	I	OELD frame signal input terminal.
22	Front-SI	I	Serial data input terminal from Main u-COM.
23	Front-SO	O	Serial data output terminal to Main u-COM.
24	Front-CLK	O	Communication synchronous CLK output terminal to Main u-COM.
25	AMB CONT	O	Amber light control terminal.
26	SR1	I	Touch Sensor input terminal of SLIDER.
27	SR2		
28	SR3		
29	SR4		
30	SR5		
31	SR6		
32	SR7	I	Click input terminal of SLIDER.
33	EVSS	-	GND terminal for Bus Interface.
34	EVDD	-	Power supply terminal for Bus Interface.
35	GRN CONT	O	Green light control terminal.
36	NC	-	No connect terminal.
37	ACTION IND	O	ACTION IND control terminal.
38	RED-CONT	O	RGB circumference light control terminal.

No.	Symbol	I/O	Terminal Description
39	RGB CS	O	RGB Chip Select output terminal.
40	RGB RST	O	RGB Reset output terminal.
41	RGB DATA	O	RGB Serial Data output terminal.
42	RGB CLK	O	RGB Serial Clock output terminal.
43	A0	-	External ROM address port terminal.
44	A1		
45	A2		
46	A3		
47	A4		
48	A5		
49	A6		
50	A7		
51	A8		
52	A9		
53	A10		
54	A11		
55	A12		
56	A13		
57	A14		
58	A15		
59	A18		
60	A19		
61	WAIT	-	WAIT terminal.
62	CLK OUT	O	CLK output terminal to OELD Controller
63	NC	-	No connect terminal.
64			
65	WR0	-	WR0 terminal.
66	IADJ	O	OELD dimmer control data output terminal.
67	RD	-	SRAM Output Enable terminal.
68	I-CLK	O	OELD dimmer control CLK output terminal.
69	BVSS	-	GND terminal for input/output port.
70	BVDD	-	Power supply terminal for input/output port.
71	AD0	-	External ROM data port terminal.
72	AD1		
73	AD2		
74	AD3		
75	AD4		
76	AD5		
77	AD6		
78	AD7		
79	AD8		
80	AD9		
81	AD10		
82	AD11		
83	AD12		
84	AD13		
85	AD14		
86	AD15		

No.	Symbol	I/O	Terminal Description
87	A16	-	External ROM data port terminal.
88	A17		
89	ROM-SEL2(NC)	-	No connect terminal.
90	ROM-SEL1	-	64Mbit ROM SEL control terminal.
91	SEG-SEL	O	External ROM address bus terminal.
92	DRIV-RESET	O	OELD Driver Reset terminal.
93	CO-RST	O	OELD Controller Reset terminal.
94	VHH-CONT2	-	OELD Vhh power supply control terminal.
95	VDD-CONT	O	Logic power supply control terminal of OELD Driver.
96	ENCODER-2	I	ENCODER input terminal.
97	ENCODER-1		
98	KEY-IN3	I	A/D Converter input terminal.
99	KEY-IN2		
100	KEY-IN1		

TMP91CP27UG : IC104 (DP23S8DA)

No.	Symbol	I/O	Terminal Description
1	VREFL	-	GND connect terminal for system BATT.
2	NC(PULL-DOWN)	-	Pull-down connect terminal.
3	E2CE(PULL-DOWN)		
4	NC(PULL-DOWN)		
5			
6	QDATAF	O	TEXT DATA confusion sync. signal output terminal for HOST interface.
7	/FIN	I	Frame input terminal from HOST u-COM.
8	REQ	I	REQ signal input terminal for Decoder (TC94A20F) interface.
9	/FOUT	O	Frame output terminal to HOST u-COM.
10	NC(PULL-DOWN)	-	Pull-down connect terminal.
11	TXD(PF_IS)	O	UART output terminal to HOST u-COM.
12	RXD(PF_IS)	I	UART input terminal from HOST u-COM.
13	NC(PULL-DOWN)	-	Pull-down connect terminal.
14	TXD(FLASH)	O	UART output terminal for Flash u-COM rewriting.
15	RXD(FLASH)	I	UART Input terminal for Flash u-COM rewriting.
16	NC(PULL-DOWN)	-	Pull-down connect terminal.
17	AM0(PULL-UP)	-	Pull-up connect terminal.
18	DVCC	-	BATT+3.3V power supply connect terminal.
19	X2	O	Crystal OSC connect terminal.
20	DVSS	-	GND connect terminal for system BATT.
21	X1	I	Crystal OSC connect terminal.
22	AM1(PULL-UP)	-	Pull-up connect terminal.
23	/RESET	I	RESET input terminal.
24	NC	-	No connect terminal.
25			
26	NC(PULL-DOWN)	-	Pull-down connect terminal.
27	NC	-	No connect terminal.
28	BUS0	I/O	DATA input/output terminal for SERVO_LSI (TC94A14FA) interface.
29	BUS1		
30	BUS2		
31	BUS3		

No.	Symbol	I/O	Terminal Description
32	/BUCK	O	CLOCK output terminal for SERVO_LSI (TC94A14FA) interface.
33	/CCE	O	Chip enable output terminal for SERVO_LSI (TC94A14FA) interface.
34	/CD_RESET	O	SERVO_LSI (TC94A14FA) RESET output terminal.
35	ZMUTEIN	I	0 detection flag input terminal for SERVO_LSI (TC94A14FA) interface.
36	NC(PULL-DOWN)	-	Pull-down connect terminal.
37	MUTE_0	O	0 MUTE signal output terminal for SERVO_LSI (TC94A14FA) interface.
38	NC(PULL-DOWN)	-	Pull-down connect terminal.
39	GVSW	O	RF-AMP (TC2157FN) AGC, TE, FE GAIN switching signal output terminal.
40	/DR_MUTE	O	MOTOR Driver (BA5985FM) MUTE output terminal.
41	MOTOR1	O	Load-MOTOR control signal output terminal. (REV)
42	MOTOR2	O	Load-MOTOR control signal output terminal. (FOR)
43	/LMT_SW	I	LIMIT detection SW signal input terminal.
44	NC(PULL-DOWN)	-	Pull-down connect terminal.
45			
48			
49	CDVCONT	O	System SERVO 3.3V power supply control output terminal.
50	/BOOT	O	BOOT output terminal for Flash u-COM rewriting.
51	NC	-	No connect terminal.
52	/DEC_RESET	O	Decoder (TC94A20F) RESET output terminal.
53	DEC_STANDBY	O	Decoder (TC94A20F) STANDBY output terminal.
54	NC	-	No connect terminal.
55			
56	NC(PULL-DOWN)	-	Pull-down connect terminal.
57	SDA	I/O	DATA input/output, EEP-ROM DATA input/output combination terminal for Decoder (TC94A20F) interface.
58	SDL	O	CLOCK output, EEP-ROM CLOCK output combination terminal for Decoder (TC94A20F) interface.
59	/STBY(PULL-UP)	-	Pull-up connect terminal.
60	/SWA	I	Disc insertion detection SW signal input terminal.
61	/SWB	I	8cm Disc Eject/reload detection SW signal input terminal.
62	/SWC	I	12cm Disc Eject/reload detection SW signal input terminal.
63	/SWD	I	Disc chucking completion detection SW signal input terminal.
64	VREFH	-	BATT+3.3V power supply connect terminal.

Exploded View (Cabinet)(1/2)

CDA-9855R

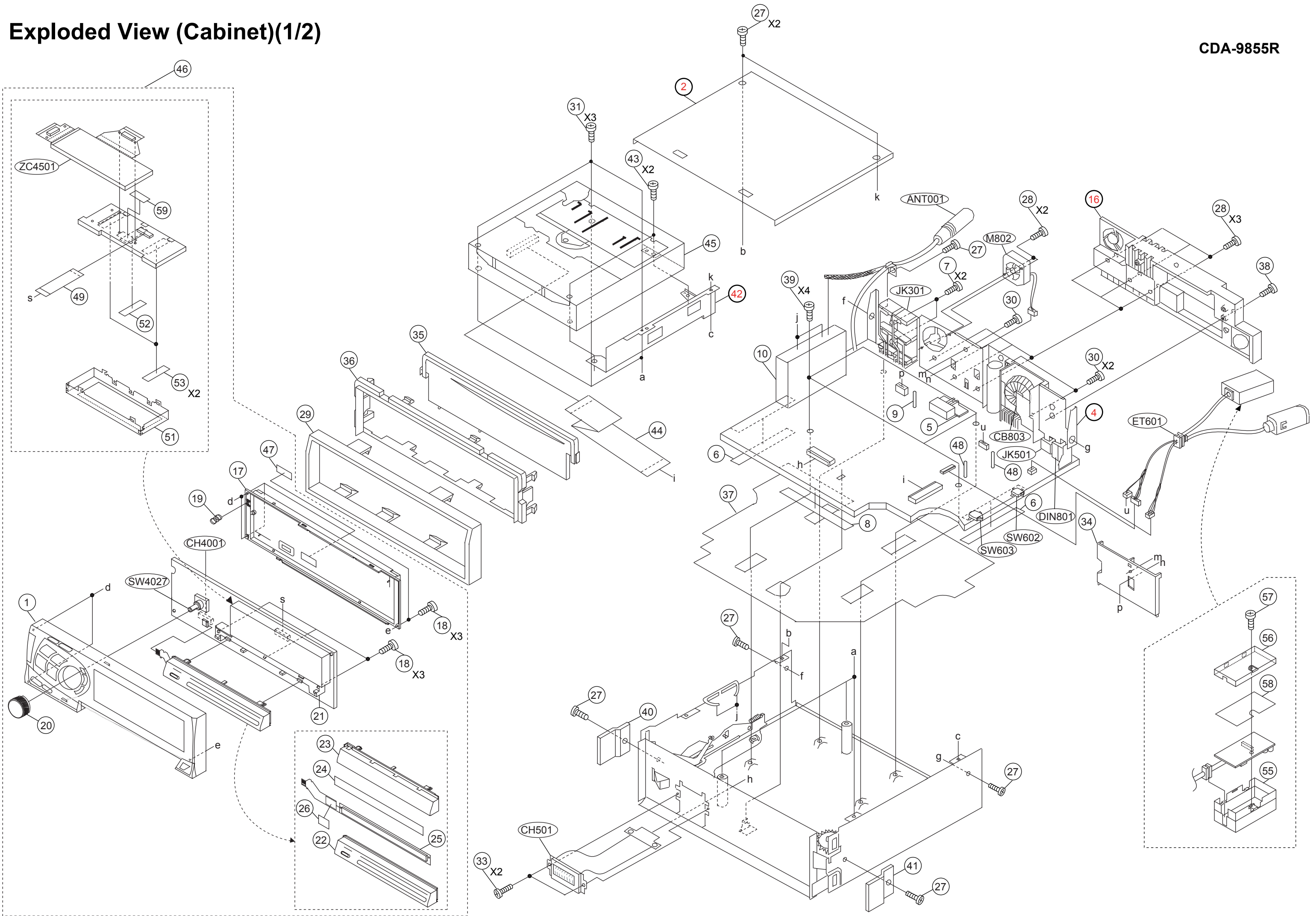

Exploded View (Cabinet)(2/2)

CDA-9855R

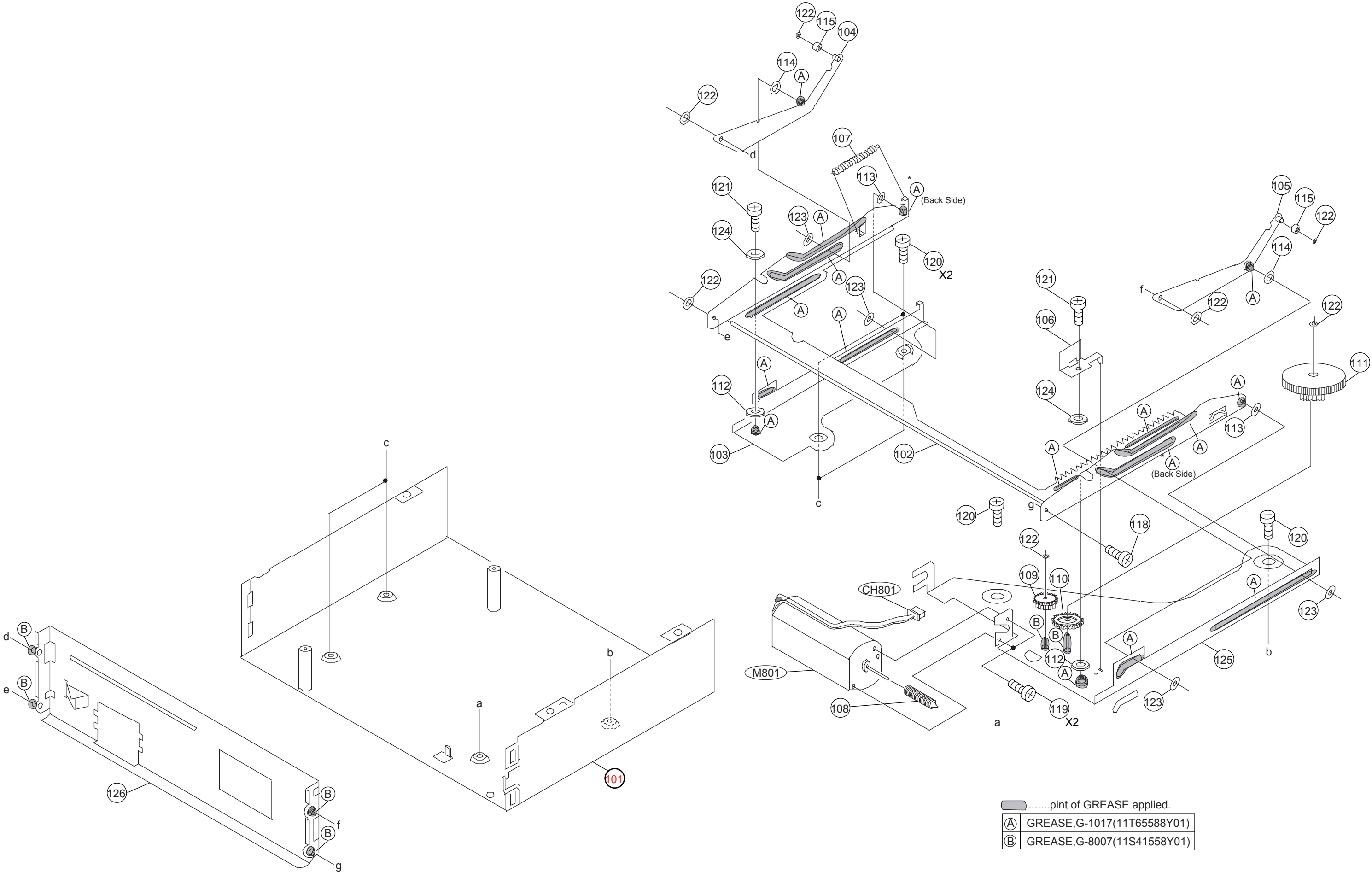

Exploded View (CD Deck Mechanism)

CDA-9855R

(DP23S8DA)

