

**NPN Silicon AF Transistor**

- For general AF applications
- High current gain
- Low collector-emitter saturation voltage
- Complementary types: BCW67, BCW68 (PNP)

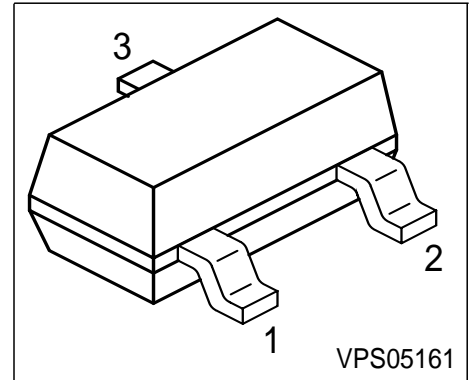

Type	Marking	Pin Configuration			Package
BCW65A	EAs	1 = B	2 = E	3 = C	SOT23
BCW65B	EBs	1 = B	2 = E	3 = C	SOT23
BCW65C	ECs	1 = B	2 = E	3 = C	SOT23
BCW66F	EFs	1 = B	2 = E	3 = C	SOT23
BCW66G	EGs	1 = B	2 = E	3 = C	SOT23
BCW66H	EHs	1 = B	2 = E	3 = C	SOT23

**Maximum Ratings**

Parameter	Symbol	BCW65	BCW66	Unit
Collector-emitter voltage	$V_{CEO}$	32	45	V
Collector-base voltage	$V_{CBO}$	60	75	
Emitter-base voltage	$V_{EBO}$	5	5	
DC collector current	$I_C$	800		mA
Peak collector current	$I_{CM}$	1		A
Base current	$I_B$	100		mA
Peak base current	$I_{BM}$	200		
Total power dissipation, $T_S = 79\text{ °C}$	$P_{tot}$	330		mW
Junction temperature	$T_j$	150		°C
Storage temperature	$T_{stg}$	-65 ... 150		

**Thermal Resistance**

Junction - soldering point <sup>1)</sup>	$R_{thJS}$	≤215	K/W
--	------------	------	-----

<sup>1)</sup>For calculation of  $R_{thJA}$  please refer to Application Note Thermal Resistance

**Electrical Characteristics** at  $T_A = 25^\circ\text{C}$ , unless otherwise specified.

Parameter	Symbol	Values			Unit
		min.	typ.	max.	
<b>DC Characteristics</b>					
Collector-emitter breakdown voltage $I_C = 10\text{ mA}, I_B = 0$	$V_{(BR)CEO}$				V
BCW65		32	-	-	
BCW66		45	-	-	
Collector-base breakdown voltage $I_C = 10\text{ }\mu\text{A}, I_B = 0$	$V_{(BR)CBO}$				
BCW65		60	-	-	
BCW66		75	-	-	
Emitter-base breakdown voltage $I_E = 10\text{ }\mu\text{A}, I_C = 0$	$V_{(BR)EBO}$	5	-	-	
Collector cutoff current $V_{CB} = 32\text{ V}, I_E = 0$	$I_{CBO}$				nA
BCW65		-	-	20	
$V_{CB} = 45\text{ V}, I_E = 0$	BCW66			20	
Collector cutoff current $V_{CB} = 32\text{ V}, I_E = 0, T_A = 150\text{ }^\circ\text{C}$	$I_{CBO}$				$\mu\text{A}$
BCW65		-	-	20	
$V_{CB} = 45\text{ V}, I_E = 0, T_A = 150\text{ }^\circ\text{C}$	BCW66			20	
Emitter cutoff current $V_{EB} = 4\text{ V}, I_C = 0$	$I_{EBO}$	-	-	20	nA
DC current gain 1) $I_C = 100\text{ }\mu\text{A}, V_{CE} = 10\text{ V}$	$h_{FE}$				-
$h_{FE}\text{-grp. A/F}$		35	-	-	
$h_{FE}\text{-grp. B/G}$		50	-	-	
$h_{FE}\text{-grp. C/H}$		80	-	-	
DC current gain 1) $I_C = 10\text{ mA}, V_{CE} = 1\text{ V}$	$h_{FE}$				
$h_{FE}\text{-grp. A/F}$		75	-	-	
$h_{FE}\text{-grp. B/G}$		110	-	-	
$h_{FE}\text{-grp. C/H}$		180	-	-	
DC current gain 1) $I_C = 100\text{ mA}, V_{CE} = 1\text{ V}$	$h_{FE}$				
$h_{FE}\text{-grp. A/F}$		100	160	250	
$h_{FE}\text{-grp. B/G}$		160	250	400	
$h_{FE}\text{-grp. C/H}$		250	350	630	

 1) Pulse test:  $t \leq 300\text{ }\mu\text{s}$ ,  $D = 2\%$

**Electrical Characteristics** at  $T_A = 25^\circ\text{C}$ , unless otherwise specified.

Parameter	Symbol	Values			Unit
		min.	typ.	max.	
<b>DC Characteristics</b>					
DC current gain 1) $I_C = 500 \text{ mA}, V_{CE} = 2 \text{ V}$	$h_{FE}$	-	35	-	-
$h_{FE}\text{-grp. A/F}$		-	60	-	
$h_{FE}\text{-grp. B/G}$		-	100	-	
$h_{FE}\text{-grp. C/H}$		-		-	
Collector-emitter saturation voltage1) $I_C = 100 \text{ mA}, I_B = 10 \text{ mA}$ $I_C = 500 \text{ mA}, I_B = 50 \text{ mA}$	$V_{CEsat}$	-	-	0.3	V
		-	-	0.7	
Base-emitter saturation voltage 1) $I_C = 100 \text{ mA}, I_B = 10 \text{ mA}$ $I_C = 500 \text{ mA}, I_B = 50 \text{ mA}$	$V_{BEsat}$	-	-	1.25	
		-	-	2	
<b>AC Characteristics</b>					
Transition frequency $I_C = 50 \text{ mA}, V_{CE} = 5 \text{ V}, f = 20 \text{ MHz}$	$f_T$	-	170	-	MHz
Collector-base capacitance $V_{CB} = 10 \text{ V}, f = 1 \text{ MHz}$	$C_{cb}$	-	6	-	pF
Emitter-base capacitance $V_{EB} = 0.5 \text{ V}, f = 1 \text{ MHz}$	$C_{eb}$	-	60	-	

**Total power dissipation  $P_{tot} = f(T_S)$**

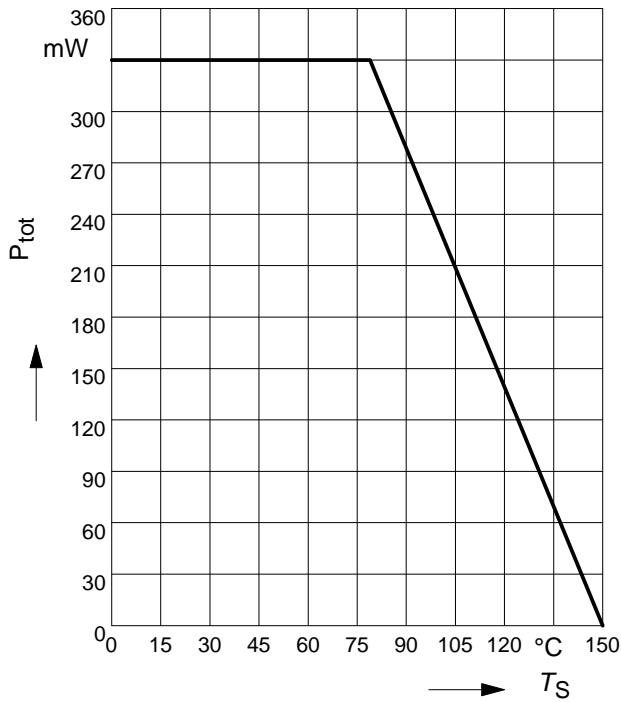

**Transition frequency  $f_T = f(I_C)$**

$V_{CE} = 5V$

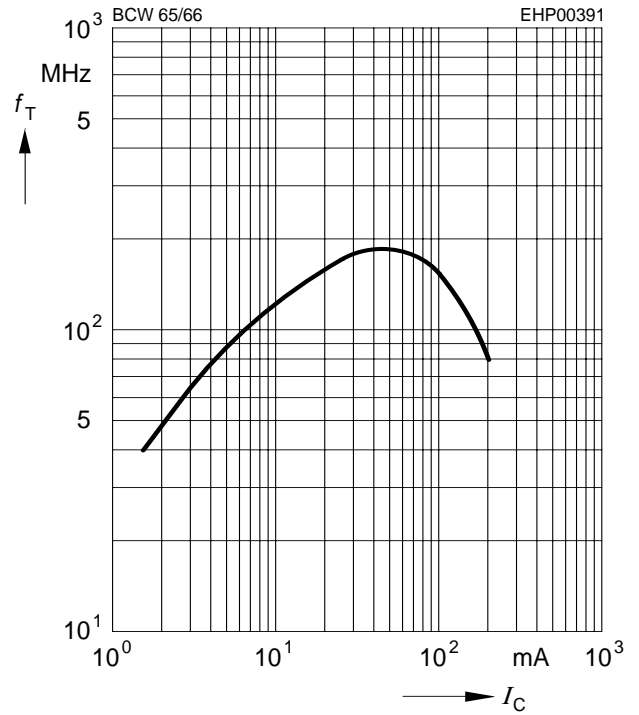

**Permissible pulse load**

$P_{totmax} / P_{totDC} = f(t_p)$

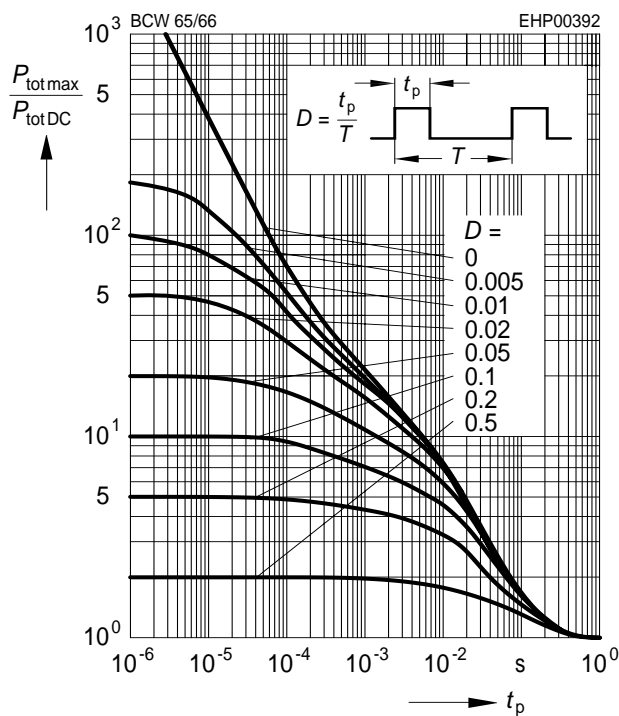

**Collector cutoff current  $I_{CBO} = f(T_A)$**

$V_{CB} = V_{CEmax}$

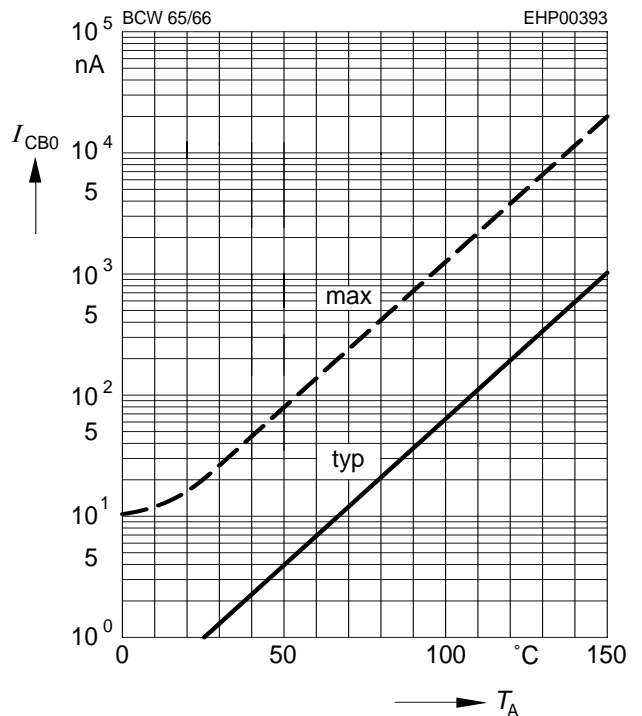

**Base-emitter saturation voltage**

$I_C = f(V_{BEsat}), h_{FE} = 10$

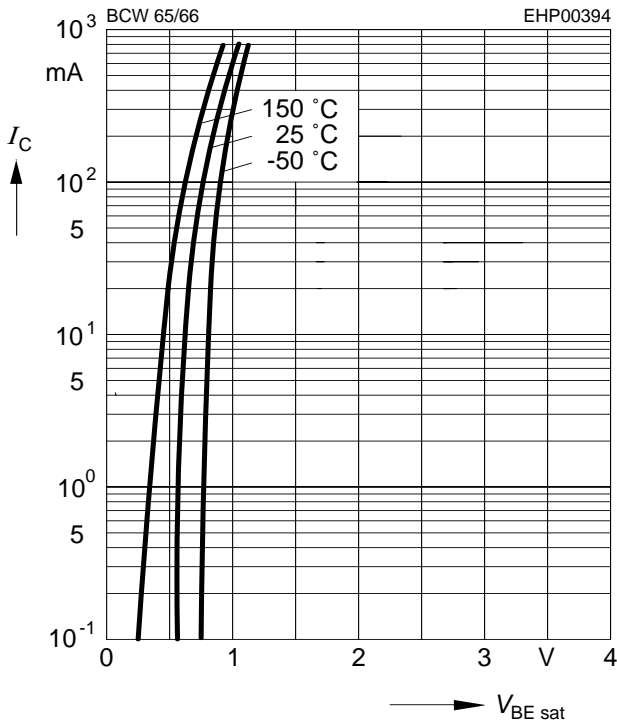

**Collector-emitter saturation voltage**

$I_C = f(V_{CEsat}), h_{FE} = 10$

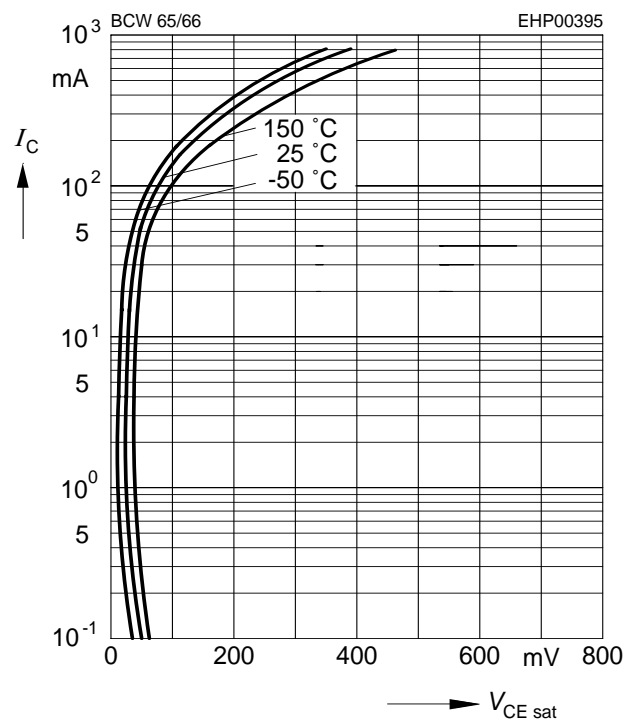

**DC current gain  $h_{FE} = f(I_C)$**

$V_{CE} = 1V$

