

MASTER

CASSETTE CAR STEREO
WITH FM/AM ELECTRONIC TUNER

SUPER TUNER

OWNER'S MANUAL

Thank you for purchasing this PIONEER product. Before attempting operation, be sure to read this manual.

Nous vous remercions d'avoir acheté cet appareil PIONEER. Avant de l'utiliser, prenez soin de lire ce manuel.

Muchas gracias por la adquisición de este producto PIONEER. Antes de tratar de operarlo, lea atentamente este manual.

شكراً لك على شرائك جهاز بايونير هذا. قبل محاولة تشغيله تأكد من قراءة هذا الدليل.



KE-3750QR

PIONEER
The Art of Entertainment

KE-3750QR
KE-3750QR

Features

- Built-in highly sensitive "Super Tuner" for automatic control of stereo separation, muting and frequency characteristics to match the strength of the FM signal.
- The Best Stations Memory automatically memorizes the six best (strongest) stations in the six preset buttons in the order of their strength.
- Preset scan tuning for sequential recall of preset frequencies.
- Auto reverse function eliminates the need to turn the cassette over and allows uninterrupted playback.
- Built-in Dolby B NR for reduced tape hiss.
(This feature is provided for the KE-3750QR.)
- Music search function allows automatic playback from the beginning of the selection being played or the beginning of the next selection.
(This feature is provided for the KE-3750QR.)
- When a power amp with RCA terminal is used in combination with a 4-speaker system equipped with built-in amp, a 4-speaker system with fader control capabilities operates as well. Build in "Flex Fader Control".
(This feature is provided for the KE-3750QR.)
- 4-speaker system creates a full-bodied listening environment.
(This feature is provided for the KE-2750QR.)
- The "Quick Release Mounting Bracket", facilitates mounting and dismounting of the car stereo and serves to protect the unit from theft.
- Dolby noise reduction manufactured under license from Dolby Laboratories Licensing Corporation. "DOLBY" and the double-D symbol  are trademarks of Dolby Laboratories Licensing Corporation.

Switching the Tuning Steps

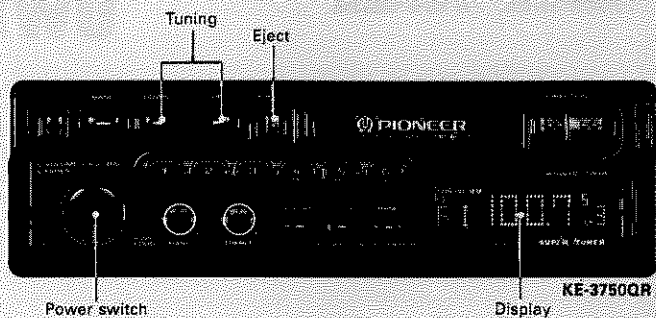

● Changing the tuning step

The tuning steps of the AM band for this unit can be switched between 9 kHz and 10 kHz per step. The tuning step should be switched from 9 kHz (which is preset at the factory) to 10 kHz when this unit is used in North America, Central America, or South America.

1. Press the eject button to eject the cassette, and then turn left the power switch to turn off the power.
2. To change the AM tuning step, hold down the up (>) or down (<) tuning button and at the same time turn the power switch to turn the power on. It should be noted that changing the tuning step also deletes frequencies stored in the tuning memories.

	Specification	Initial Setting	New Setting
AM	Tuning steps	9 kHz steps	10 kHz steps
	Frequency range	531 — 1,602 kHz	530 — 1,710 kHz

Connections

Note:

- To avoid shorts in the electrical system, be sure to disconnect the battery \ominus cable before beginning installation.
- Replace the fuse only with the type stipulated on the fuse holder.
- Be sure to properly connect the color coded leads. Failure to do so can cause malfunctions.
- Cover unused terminals with tape to prevent electrical shorts.
- Refer to the power amp owner's manual when connecting a power amp (sold separately) to the RCA pin jack. (KE-3750QR)
- When the power amp is being linked with this system, be sure not to connect the blue lead to the amp's power terminal. Likewise, when linking this system with the auto-antenna, do not connect to power terminal for the antenna. Such connection can make overcurrent cause malfunctions.

Black (ground)	To vehicle (metal) body.
Blue	If this unit is combined with a power amp, connect its blue lead to the blue lead (system control terminal) of the power amp. If combined with an auto-antenna, connect its blue lead to the relay control terminal of the auto-antenna. (MAX. 300 mA, 12 V DC)
Red	To electric terminal controlled by ignition switch (12 V DC) ON/OFF.

2-speaker system

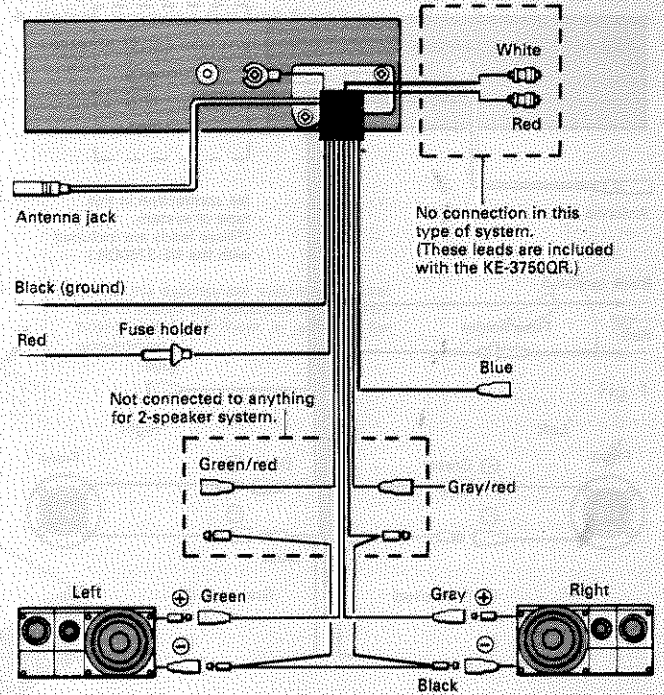

4-speaker system 1

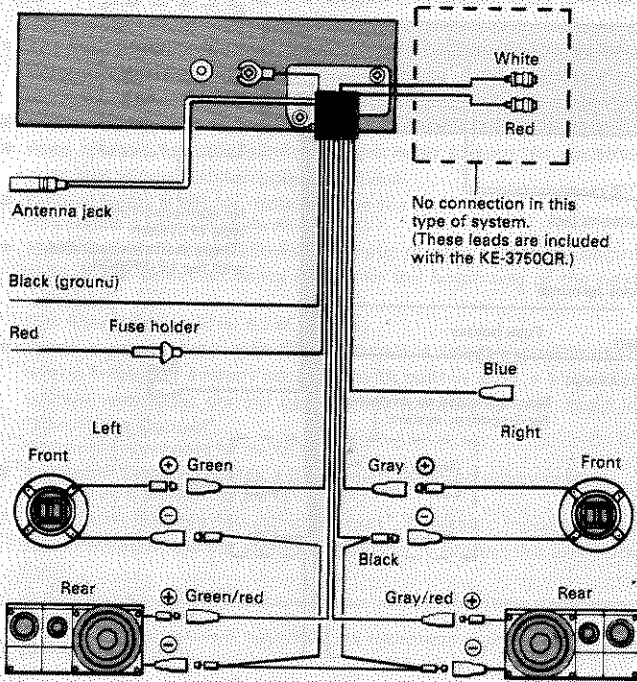

4-speaker system 2 (Using separately available amp.) (KE-3750QR)

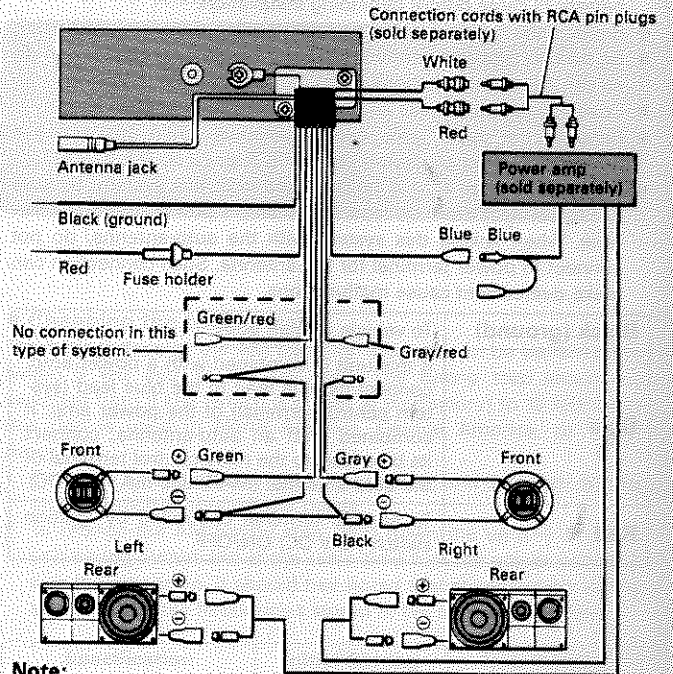

Note:

Connect to the front speakers with the green and gray leads. If you connect with the green/red and gray/red leads, this unit's fader control will not operate.

Installation

Note:

- Use only the parts included with the unit to ensure proper installation. The use of unauthorized parts can cause malfunctions.
- Consult with your nearest dealer if installation requires the drilling of holes or other modifications of the vehicle.

- If installation angle exceeds 30° from horizontal, the unit might not give its optimum performance. (Fig. 1)
- Before removing this unit from your vehicle, be sure to remove cassette tapes and make sure that radio power is switched OFF.

Installation with the rubber bush

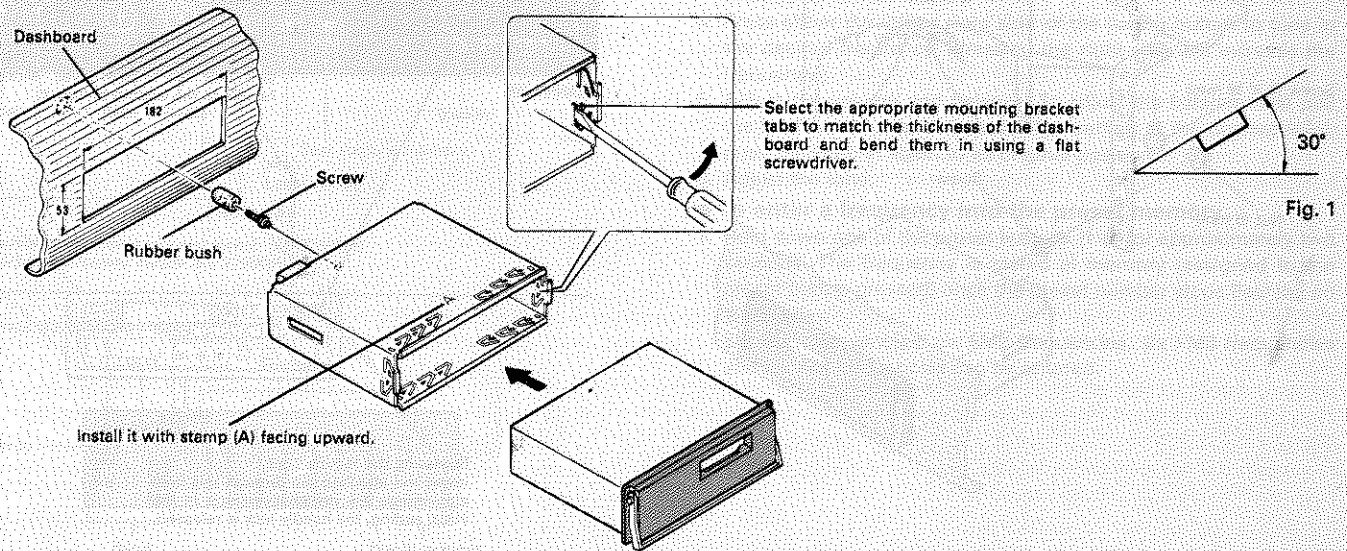

Installation without the rubber bush

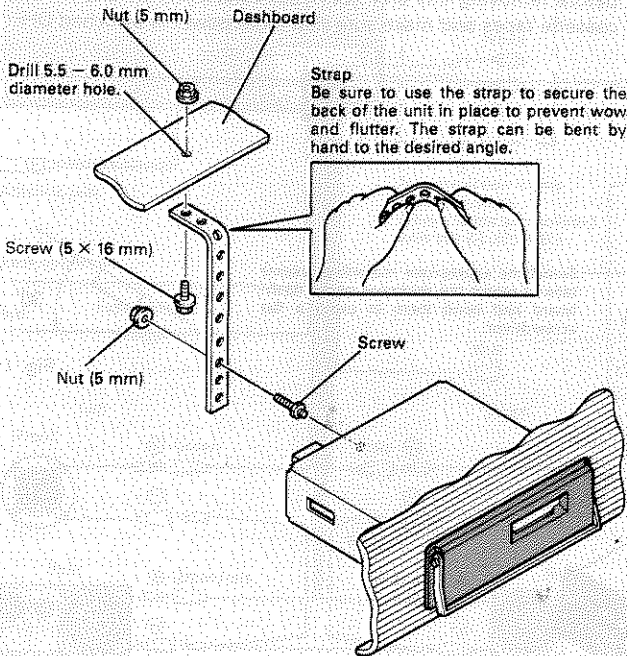

Locking and Releasing Quickrelease Handle

Push the pop-up button in the mechanism to move the quickrelease handle moves up slightly. If the quickrelease mechanism will not be used, you can lock the handle, keeping it down.

Pop-up button

When the quickrelease handle is on the bottom, push the button to move it up slightly. Push it when you remove the unit from the dashboard. The button works only when the handle lock is released.

Locking the Handle

Insert the attached pin through this hole and lock the inside lever. Move the handle to the bottom to lock it.

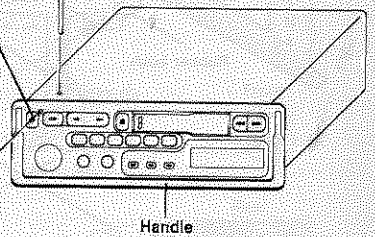

Releasing the Handle Lock

Insert the attached pin through this hole and release the inside lever lock. In the initial setting, the handle lock is released.

Using the Radio

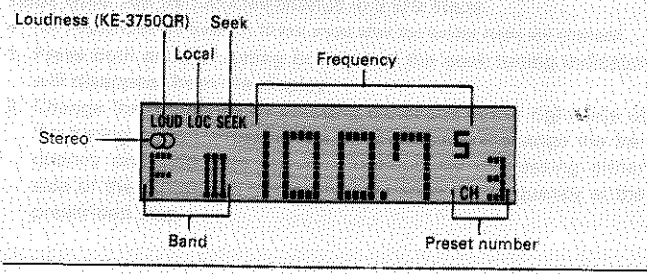
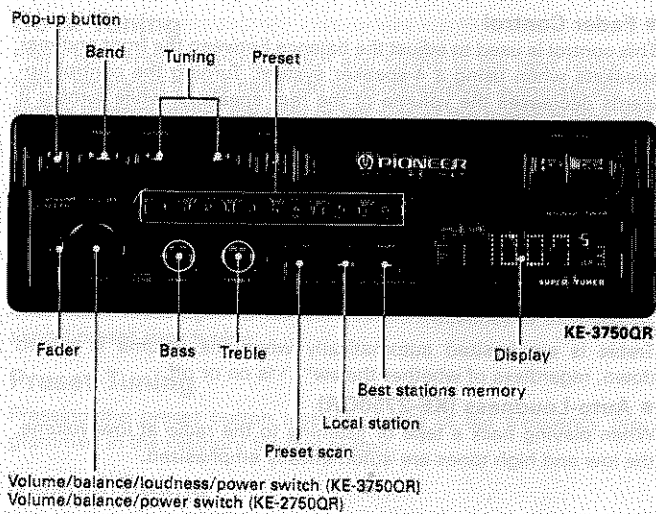

● **Before attempting operation...**

- Set the fader control to the left horizontal.
- 1. Turning the power switch to the right causes power to switch ON and the current frequency to appear on the display.
- Since the set is designed preferentially for tape play, eject a cassette tape, if mounted, before operating the radio.
- 2. Press the band switch to select the band.
- 3. Press both ends of tuning button and the seek tuning indicator will appear on the display.
- 4. Press either the left or right side of the tuning button to tune in the desired frequency. (Pressing the right side will increase the frequency.)
- 5. Adjust the volume and balance. To adjust the balance, first pull the knob until a click is heard. After setting to the desired level, push the knob in again to its original position.
- 6. Adjust the tone.

● **To enter a frequency into the preset memory...**

- 7. Hold down one of the preset buttons (1-6) for approximately two seconds. The frequency is stored in memory (assigned to the preset button pressed) once the preset number stops flashing on the display.
- Six FM1 frequencies, six FM2 frequencies, six FM3 frequencies and six AM frequencies can be entered.

● Best Stations Memory Button

Automatically tunes strong frequencies and assigns them to preset buttons 1 through 6 for one-touch automatic tuning. The best stations memory function is activated by pressing this button for approximately 2 seconds. The best stations memory function is indicated by — flashing on the display, and this function can be canceled by pressing the band switch. The frequency display returns once the best stations memory function is complete. The frequency displayed at this time is of the strongest station assigned to preset button 1 by the best stations memory function.

- 6 best (strongest) frequencies are memorized in the 6 preset buttons in the order of their strength, the strongest one being assigned to preset button 1.
- The frequencies previously assigned to the preset buttons are retained when 6 frequencies cannot be located.
- The best stations memory is in operation while — is flashing on the display.

● Local Station Switch

Pressing this switch increases the seek threshold level so that only relatively strong stations can be tuned in (local indicator will illuminate on the display). Local seek threshold level can be selected among four levels for FM and two levels for AM.

Holding this switch down for approximately 2 seconds and then pressing the right side of the tuning button changes the display from L-1, L-2, L-3 to L-4. Pressing the left side of the tuning button changes the display from L-4, L-3, L-2 to L-1 (L-1 and L-2 for AM). The bigger the number, the higher the seek threshold becomes and only relatively strong stations can be tuned in.

● Fader Control

This control is used to adjust the balance between the front and rear speakers when using a 4-speaker system. Turning the control upwards decreases the volume of the rear speakers, while turning it downwards decreases the volume of the front speakers. With 2-speaker systems, set this control to a horizontal position.

A considerable amount of sound will continue to be produced from speakers of a 4-speaker system which have been cut by setting the fader control either to the front speakers or rear speakers. This is normal and does not indicate malfunction.

● Loudness Switch (KE-3750QR)

When playing back a tape or listening to the radio at low volume, the low tone is emphasized and more clearly heard by pressing this switch.

Treble is emphasized automatically when the volume is turned down, regardless of whether the switch is on or off.

● Auto-Loudness (KE-2750QR)

When playing back a tape or listening to the radio at low volume, the low and high tones are automatically emphasized.

Seek Tuning

Press both ends of tuning button and tuning to the next higher or lower broadcast on the band can be accomplished automatically by simply pressing either the right or left side of the tuning button. FM frequencies change in 50 kHz steps while those in the AM band change in 9 kHz steps.

- AM frequencies are tuned in 10 kHz steps after the tuning steps are changed.

Preset Scan Tuning

Pressing the preset scan button (CH indicator flashes) causes previously stored frequencies to be tuned in sequentially for eight seconds each. Press again when the desired frequency is tuned in to cancel preset scan tuning.

Preset Tuning

Pressing the preset button instantly tunes in the frequency programmed in the memory for that button.

Manual Tuning

When manual tuning is employed, FM frequencies change in 50 kHz steps while AM frequencies change in 9 kHz steps.

- AM frequencies are tuned in 10 kHz steps after the tuning steps are changed.
1. Press both ends of tuning button and the seek tuning indicator will disappear from the display.
 2. Change the frequency by pressing either the left or right side of the tuning button. Pressing the button once will change the frequency one step (see above). Continuously depressing either side of the button will successively change the frequency at the prescribed step.

• Pop-up button

When the quickrelease handle is on the bottom, push the button to move it up slightly. Push it when you remove the unit from the dashboard.

The button works only when the handle lock is released.

Before removing this unit from your vehicle, be sure to remove cassette tapes and make sure that radio power is switched OFF.

Using the Tape Deck

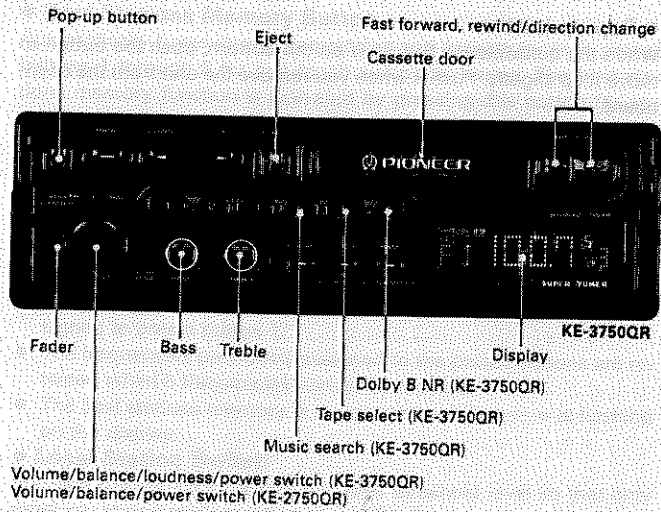

• Before attempting operation...

- Set the fader control to the left horizontal.
- 1. Turning the power switch to the right causes power to switch ON.
- 2. Loading a cassette tape into the load slot causes playback to begin automatically.
- 3. Adjust the volume and balance. To adjust the balance, first pull the knob until a click is heard. After setting to the desired level, push the knob in again to its original position.
- 4. Adjust the tone.
- 5. When tape playback reaches the end of the tape, playback will automatically switch from the side being played to the opposite side (ie. Side A to Side B or vice versa) (Auto-reverse). To eject the tape during playback, press the eject button.
- A loose or warped label on a cassette tape may interfere with the eject mechanism of the unit or cause the cassette to become jammed in the unit. Avoid using such tapes or remove such labels from the cassette before attempting use.
- Do not try to eject the cassette immediately after insertion, as it will cause malfunction. Wait a few seconds.
- Loose tapes should be rewound with the aid of a pencil and unevenly wound tapes rewound with the use of the fast forward function.
- Be sure to eject the tape when the vehicle's ignition is turned OFF. Leaving the tape in the unit can deform the pinch roller causing wow and flutter during tape playback.

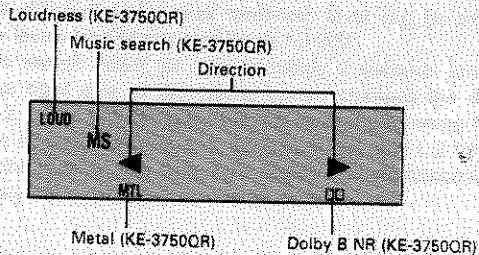

● **Fast Forward/Rewind**

Since the transport can be in either direction, both the left and right high-speed tape transport buttons can be regarded as fast forward/rewind buttons.

For fast forward, press the high-speed tape transport button that corresponds to the direction that is shown by the direction indicator. When the end of the tape is reached, playback will automatically begin from the opposite side of the tape (Auto-reverse).

For rewind, press the button that is opposite that of the direction shown by the direction indicator. When the end of the tape is reached, playback will automatically begin from the beginning of the same side of the tape (Auto-replay).

Fast forward and rewind can be terminated by pressing the respective opposite high-speed tape transport button.

● **Direction Change**

Push the fast forward and rewind buttons together to switch from one side of the tape to the other (from Side A to Side B or vice versa).

● **Dolby B NR Switch (KE-3750QR)**

Press when playing a tape recorded with Dolby NR.

● **Tape Select Switch (KE-3750QR)**

This switch is used to switch to the proper mode for the tape being used and should be depressed when using chrome or metal tapes.

Music Search (KE-3750QR)

● **Returning to the beginning of selection A**

Press the music search button and then the high-speed tape transport button for the direction opposite that is shown by the direction indicator. Playback will automatically start from the beginning of selection A.

● **Moving from selection A to selection B**

Press the music search button and then the high-speed tape transport button that corresponds to the direction shown by the direction indicator. Playback will automatically start from the beginning of selection B.

To enable regular fast forward/rewind operations, press the music search button again to turn the function OFF. The following errors will cause the music search function to operate improperly, even though the unit is not malfunctioning.

- Unrecorded "blank" portions between selections less than 4 seconds → the blank portion cannot be detected by the unit.
- Pauses in recorded conversations longer than 4 seconds → the unit reads these as blanks between selections.
- Portions recorded at very low volume for more than 4 seconds → the unit reads these as blanks between selections.

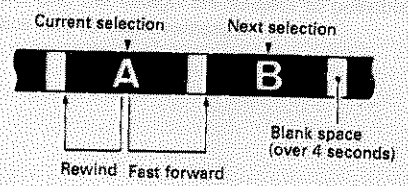

Care and Maintenance

- Do not use tapes longer than C-90-type (90 min.) cassettes. Longer tapes can interfere with tape transport.
- If the playback head becomes dirty, sound quality will suffer. Periodically (once or twice a month) clean the head with a cotton swab soaked with alcohol. (Fig. 1)
- Storing cassettes in areas directly exposed to sunlight or high temperatures can distort them and subsequently interfere with tape transport. (Fig. 2)
- Store unused tapes in a tape case where there is no danger of them becoming loose or being exposed to dust.
- **After Service**

In the event this unit does not function properly, contact your dealer or the nearest authorized PIONEER Service Center.

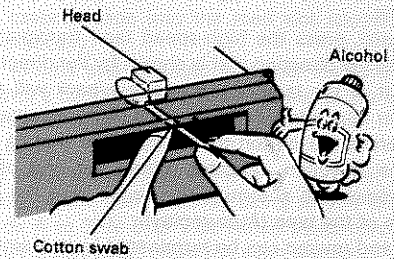

Fig. 1



Fig. 2

Specifications

General

Power source 14.4 V DC (10.8 — 15.6 V allowable)
Grounding system Negative type
Max. current consumption 2.5 A
Dimensions (chassis) 178(W) × 50(H) × 141(D) mm
(nose) 188(W) × 58(H) × 16(D) mm
(mounting bracket) 182(W) × 52(H) × 152.5(D) mm
Weight 1.3 kg

Amplifier

Continuous power output is 3.2 W per channel min. into 4 ohms, both channels driven 50 to 15,000 Hz with no more than 5% THD.
Maximum power output 8.5 W × 2/7 W × 4 (EIAJ)
Load impedance 4 Ω (4 — 8 Ω allowable)
Preout output level/impedance (KE-3750QR) 500 mV/100 Ω
Tone controls (bass) ±10 dB (100 Hz)
(treble) ±10 dB (10 kHz)
Loudness contour
(KE-3750QR) +10 dB (100 Hz), +4 dB (10 kHz)
(volume: -30 dB)
(KE-2750QR) +8 dB (100 Hz), +4 dB (10 kHz)
(volume: -30 dB)

Tape player

Tape Compact cassette tape (C-30 — C-90)
Tape speed 4.8 cm/sec.
Fast forward/rewind time Approx. 100 sec. for C-60
Wow & flutter 0.13% (WRMS)
Frequency response
(KE-3750QR) Metal: 50 — 17,000 Hz (±3 dB)
(KE-2750QR) 50 — 14,000 Hz (±3 dB)
Stereo separation 45 dB

Signal-to-noise ratio

(KE-3750QR) Metal: Dolby B NR IN: 63 dB (IEC-A network)
Dolby NR OUT: 55 dB (IEC-A network)
(KE-2750QR) 52 dB (IEC-A network)

FM tuner

Frequency range 87.5 — 108 MHz
Usable sensitivity 11 dBf (1.0 μV/75 Ω, mono, S/N: 30 dB)
50 dB quieting sensitivity 16 dBf (1.7 μV/75 Ω, mono)
Signal-to-noise ratio 70 dB (IEC-A network)
Distortion 0.3% (at 65 dBf, 1 kHz, stereo)
Frequency response 30 — 15,000 Hz (±3 dB)
Stereo separation 40 dB (at 65 dBf, 1 kHz)

AM tuner

Frequency range 531 — 1,602 kHz (9 kHz)
530 — 1,710 kHz (10 kHz)
Usable sensitivity 18 μV (25 dB) (S/N: 20 dB)
Selectivity 50 dB (±9 kHz)
50 dB (±10 kHz)

Note:

Specifications and the design are subject to possible modification without notice due to improvements.

PIONEER ELECTRONIC CORPORATION

4-1, Meguro 1-chome, Meguro-ku, TOKYO, 153, JAPAN

PIONEER ELECTRONICS (USA) INC.

P.O. Box 1760, Long Beach, California 90801, U.S.A.

TEL: (800) 421-1404

PIONEER ELECTRONIC (EUROPE) N.V.

Keetberglaan 1, 2740 Beveren, Belgium

TEL: 03/750.05.11

PIONEER ELECTRONICS AUSTRALIA PTY. LTD.

178-184 Boundary Road, Braeside, Victoria 3195, Australia

TEL: (03) 580-9911

PIONEER ELECTRONICS OF CANADA, INC.

505 Cochrane Drive Markham, Ontario L3R 6B8, Canada

Published by the Pioneer Electronic Corporation.
Copyright 1990 by Pioneer Electronic Corporation.
All rights reserved.

<90K06F5Y01>

Printed in Japan
<CRD1402-A> ES