

GX204KEF2/KHF2 GX204LEF2/REF2 GX204SEF2 SERVICE MANUAL

KENWOOD

Kenwood Corporation

© 2006-6 CREATED IN JAPAN
B53-0427-00 (N) 0

SUBARU GENUINE

- The knobs with numbers larger than 700 on exploded view are not supplied for service parts because it is difficult to apply grease. Please change to panel assy when you need repair to the knob.
- The 6CD mechanism has not supplied repair parts for each part (for Optical Laser pickup, motor etc). If you need repair to the 6CD mechanism please change to mechanism assy (D40-2214-15).

Model	Model Name	Parts No.
GX-204KE	GX204KEF2	86201AG290
GX-204KH	GX204KHF2	86201AG250
GX-204LE	GX204LEF2	86201AG460
GX-204RE	GX204REF2	86201AG350
GX-204SE	GX204SEF2	86201AG550

DC cord for service	E30-3801-15
ANT extension cord for service	E30-6255-05

Panel assy (Y33-2570-23): GX204KEF2
(Y33-2570-24): GX204KHF2
(Y33-2572-73): GX204REF2

GX204KEF2

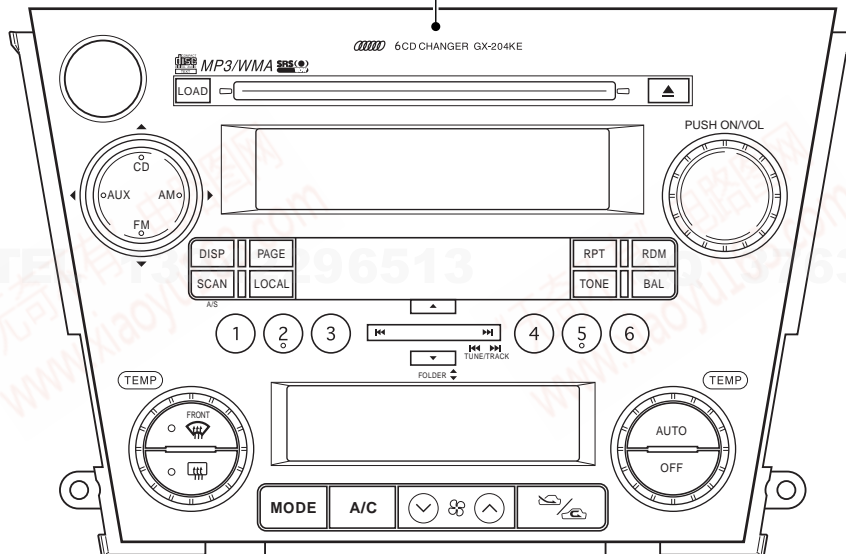

GX204REF2

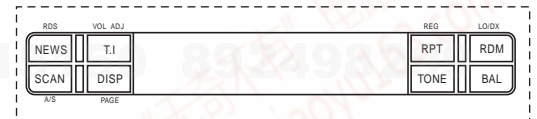

GX204KHF2

Panel assy (Y33-2570-12): GX204SEF2
(Y33-2572-74): GX204LEF2

GX204LEF2

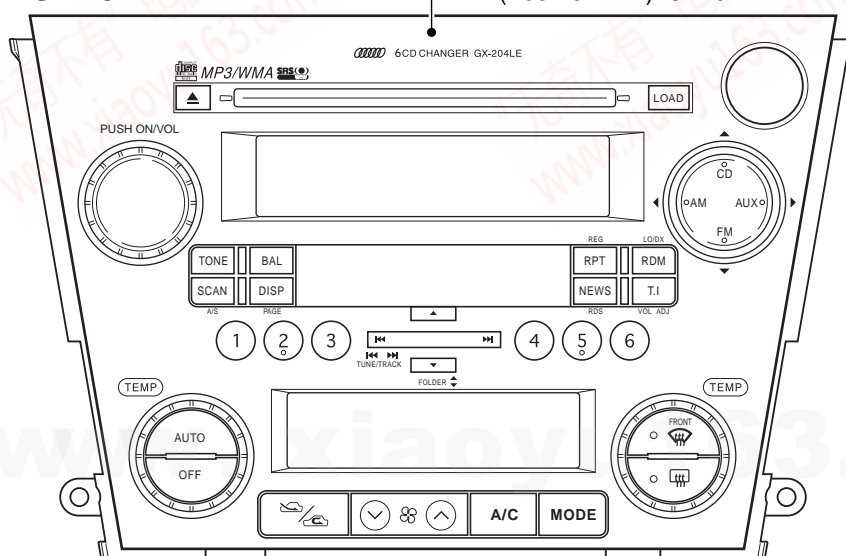

GX204SEF2

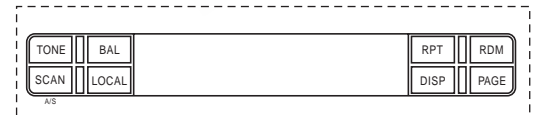

BLOCK DIAGRAM

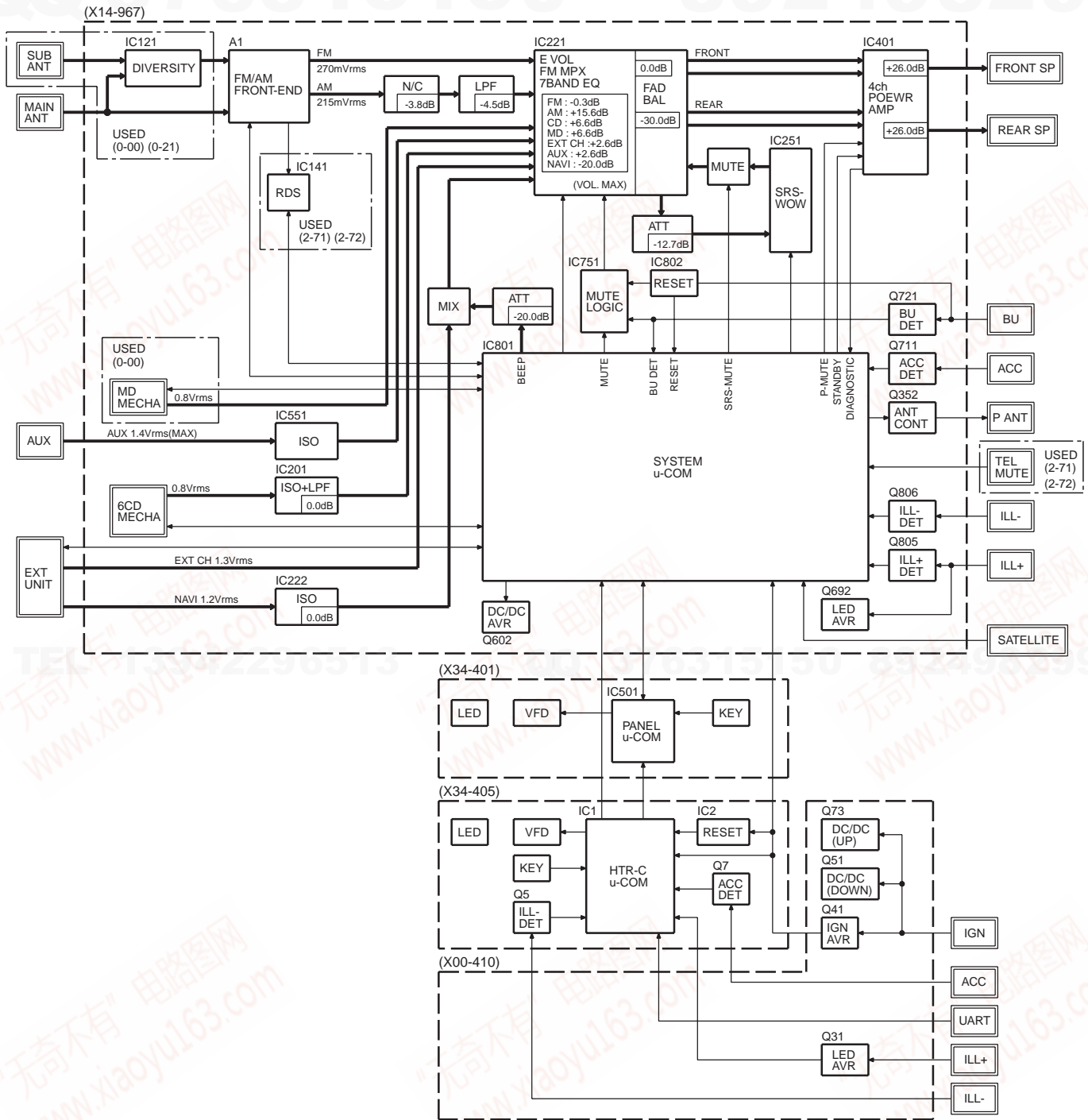

COMPONENTS DESCRIPTION

● POWER SUPPLY UNIT (X00-4100-00)

Ref. No.	Application / Function	Operation / Condition / Compatibility
Q31	Power supply for illumination LED	Stabilizes illumination LED voltage (8.1V) and supplies required current.
Q41	Power supply for IGN5V	Stabilizes IGN5V voltage (5.1V) and supplies required current.
Q51	Step-down DC/DC switching	Converts voltage by switching.
Q53	Power supply for VFD filament	Stabilizes VFD filament voltage (2.9V) and supplies required current.
Q54	Power supply for VFD filament	Configures Darlington with Q53.
Q55	Power supply SW for VFD filament	ON/OFF filament power supply by μ -com FL_FIL_ON signal. (ON with μ -com L output)
Q61	Power supply for DC/DC converter	Stabilizes DC/DC input voltage (9.5V) and supplies required current.
Q62	Power supply for DC/DC converter	Configures Darlington with Q61.
Q71	Step-up DC/DC timing control	Controls step-up DC/DC switching.
Q72	Step-up DC/DC switching	Converts voltage by switching.
Q73	Step-up DC/DC output voltage switching	Detects output voltage and controls switching timing.

● SYNTHESIZER UNIT (X14-967x-xx)

Ref. No.	Application / Function	Operation / Condition / Compatibility
IC121	FM diver IC	FM diver
IC141	RDS demodulation IC	Demodulates RDS
IC143	Amplifier for filters	RDS noise amplifier
IC171	AM noise canceller IC	AM noise canceller
IC201	Amplifier for isolation	6CD isolation
IC221	Audio control IC	BASS/MID/TRE, MPX, mute, electric volume
IC251	Audio control IC	WOW control
IC301	Amplifier for midpoint potential output	Outputs midpoint potential (6.8V, 4V).
IC391	Servo 8V power supply	Servo 8V power supply driver
IC401	Power amplifier IC	Power amplifier with 4CH
IC521	I2C bus IC	Sie-BUS communication
IC551	Isolation IC	AUX isolation
IC651	D3.3V power supply	Power supply driver for 6CD mechanism Bu3.3V.
IC671	D5V power supply	Power supply driver for 6CD/MD mechanism DSP5V.
IC681	C3.3V power supply	Power supply driver for 6CD mechanism DSP3.3V.
IC751	Mute logic IC	For hardware mute.
IC801	System μ -com	System control
IC802	Reset IC	Detects system reset.
IC952	Level shift IC	Level-shifting (3.3V \rightarrow 5V)
Q101	IF count detection	Outputs Lo when IF count is detected.
Q102	AM power supply switch	Outputs 8V when AM.
Q103	RDS data buffer	Outputs RDS buffer
Q121	Diver switch	Detects diver ON/OFF.
Q122	FM S meter switch	Outputs S meter voltage when FM.
Q123	Diver IC power supply switch	Outputs Hi when AM_OFF.
Q124	Diver IC power supply switch	Outputs Lo when AM.

COMPONENTS DESCRIPTION

Ref. No.	Application / Function	Operation / Condition / Compatibility
Q141	Noise amplifier	Switches constant when noise is detected.
Q142	Noise amplifier	Noise detection output buffer
Q143	Noise amplifier	Switches constant when noise is detected.
Q221	Mute switch	Mute within the electric volume.
Q222	Switch within the electric volume	For switching FM/AM within the electric volume.
Q223,224	Mute switch	SRS-WOW mute
Q301	Midpoint circuit discharge switch	Discharges the midpoint voltage when ACC_OFF.
Q303	Midpoint circuit discharge switch	Detects P-ON for discharging midpoint voltage when ACC_OFF.
Q304	Midpoint circuit discharge switch	Discharges the midpoint voltage when ACC_OFF.
Q331	Servo 8V power supply switch	Detects P-ON for servo 8V.
Q332	Servo 8V power supply switch	Driver for servo 8V.
Q333	Servo 8V power supply switch	Darlington for servo 8V.
Q351	Power supply switch for P-ANT	Detects Acc for P-ANT.
Q352	Power supply switch for P-ANT	Driver for P-ANT.
Q353	Power supply switch for P-ANT	Darlington for P-ANT.
Q354	P-ANT short detection switch	Detects P-ANT short.
Q371~373	DC offset detection switch	Detects DC offset voltage.
Q391	Audio8V power supply switch	Detects P-ON for Audio8V.
Q392	Audio8V power supply switch	Driver for Audio8V.
Q521	Current buffer for SYS_ON	Outputs Hi when SYS_ON is Lo.
Q522	Current buffer for SYS_OFF	Outputs Hi when SYS_OFF is Lo.
Q523	Bus_OFF detection	Inputs Hi when Sie-Bus system is OFF.
Q524	Bus_ON detection	Inputs Hi when Sie-Bus system is ON.
Q525	Hardware reset switch	Outputs Lo when hardware reset is detected.
Q526	Sie-Bus reset detection switch	Outputs Hi when Sie-Bus reset is detected.
Q551	AUX detection switch	Outputs Hi when AUX is detected.
Q601	Power supply switch for DC/DC45V	Detects DC/DC switch.
Q602	Power supply switch for DC/DC45V	Driver for DC/DC45V power supply.
Q603	Power supply switch for DC/DC45V	Darlington for DC/DC45V power supply.
Q604-606	Switching for DC/DC45V power supply	For DC/DC45V power supply.
Q621	Switch for filament power supply	Detects DC/DC switch.
Q622	Switch for filament power supply	Driver for filament power supply.
Q623	Switch for filament power supply	Darlington for filament power supply.
Q624	Power supply switch for DC/DC45V	Detects DC/DC switch.
Q625	Power supply switch for DC/DC45V	Driver for DC/DC45V power supply.
Q626	Switch for filament power supply	Driver for filament power supply.
Q651	Switch for Bu5V power supply	Driver for Bu5V power supply.
Q652	Switch for Bu5V power supply	Darlington for Bu5V power supply.
Q671	Switch for D5V power supply	Detects P-ON for D5V power supply.
Q672	Switch for D5V power supply	Outputs Lo when AM.
Q673	Switch for D5V power supply	Supplies D5V power supply when AM.

COMPONENTS DESCRIPTION

Ref. No.	Application / Function	Operation / Condition / Compatibility
Q674	Switch for D5V power supply	Outputs Lo when AM.
Q691	Switch for ILL power supply	Detects ILL+ for ILL power supply.
Q692	Switch for ILL power supply	Driver for ILL power supply.
Q693	Switch for ILL power supply	Darlington for ILL power supply.
Q694	Switch for ILL power supply	Driver for ILL power supply.
Q711	Acc detection switch	Outputs Lo when Acc_ON.
Q721	Bu detection switch	Outputs Lo when Bu_ON.
Q722	Over-voltage detection switch	Detects Bu over-voltage.
Q801	P-ON5V power supply switch	Driver for P-ON5V power supply.
Q802	Sie-BUS mute output	Outputs Hi when mute ON.
Q803	Switch for ILL- level shift	Converts ILL- (13.2V → 5V).
Q804	ILL+ detection switch	Detects ILL+.
Q805	Switch for ILL- level shift	Converts ILL- (13.2V → 5V).
Q806	ILL- detection switch	Detects ILL-.
Q807	Switch for SRS-WOW mute	Outputs Hi when mute ON.
Q808	Switch for level-shift	Level-shifting (5V → 3.3V)
Q809	Switch for 6CD mute	Outputs Lo when mute is requested from 6CD mechanism.
Q810	Switch for level-shift	Level-shifting (5V → 3.3V)

● SWITCH UNIT (X34-401x-xx) (AUDIO)

Ref. No.	Application / Function	Operation / Condition / Compatibility
IC501	Audio panel μ -com	Fluorescent indicator tube, Key matrix control
Q501	For cut-off bias setting PNP transistor	When displaying with fluorescent indicator tube, filament (-) terminal is approximately 3.0V.
Q502	For fluorescent indicator tube power switch PNP transistor	Base voltage L: ON, H: OFF

● SWITCH UNIT (X34-405x-xx) (H/C)

Ref. No.	Application / Function	Operation / Condition / Compatibility
IC1	Heater control panel μ -com	Vehicle ECU, communication with audio-side μ -com, key import, display data transmission, illumination control
IC2	Reset IC	When μ -com power supply voltage is 4.2V or less, reset the μ -com.
IC3	E2PROM	Stores ROM correction data
Q1	UART+	Interface for UART communication (transmission) with vehicle.
Q2	UART-	Interface for UART communication (reception) with vehicle.
Q3	Power switch	ON/OFF VH voltage application of VFD.
Q4	Power switch	ON/OFF Q3 by taking IGN_DET and DD_ON logic.
Q5	ILL- signal detection	Transmit ILL- signal from vehicle to μ -com and Q13.
Q7	ACC voltage detection	Detects ACC voltage from the vehicle.
Q11	Illumination LED control switch	Controls ON/OFF and the luminance of LED for front DEF.
Q12	Illumination LED control switch	Controls ON/OFF and the luminance of LED for rear DEF.
Q13	Illumination LED control switch	Controls ON/OFF and the luminance of LED for key illumination.

MICROCOMPUTER'S TERMINAL DESCRIPTION

● SYSTEM MICROCOMPUTER: 703037HYGM04A (X14: IC801)

Pin No.	Pin Name	I/O	Application	Truth Value Table	Processing Operation Description
1	SP_DATA_S	O	System μ -com \rightarrow Panel μ -com data output		UART 19200bps
2	TUN_SDA	I/O	F/E I2C data input/output terminal		
3	NC	O	Not used		Output L fixed
4	TUN_SCL	I/O	F/E I2C clock output terminal		
5	NC	O	Not used		Output L fixed
6	SH_DATA_H	I	HTR-C μ -com \rightarrow System μ -com data output		UART 4800bps
7	SH_DATA_S	O	System μ -com \rightarrow HTR-C μ -com data output		UART 4800bps
8	CDX_MTS	O	6CD communication request output		L: Communication request to 6CD, H: Other
9	EVDD		5V potential		
10	EVSS		GND potential		
11	BEEP	O	BEEP output		3kHz BEEP output (pulse), L: Not active
12	AM_BYPS	O	D5V bypass power ON in AM		H: AM, L: Other
13	TEL_MUTE	I	TEL_MUTE request input (E type only)		L: TEL_MUTE request
13	NC	O	Not used (In other than E type)		Output L fixed
14	ILL_DET+	I	ILL+ detection		ILL ON: L
15	ILL_DET-	I	ILL- detection (pulse input)		H: ON, L: OFF, pulse input Adjusts luminance with duty ratio.
16	VOL_SDA	I/O	E_VOL I2C data input/output		
17	VOL_SCL	I/O	E_VOL I2C clock output		
18~20	NC	O	Not used		Output L fixed
21	IC/VPP		(FLASH writing)		(FLASH writing)
22~25	NC	O	Not used		Output L fixed
26	BUS_DI	I	Sie-BUS data IN		BUS data input
27	BUS_DO	O	Sie-BUS data OUT		BUS data output
28	CDX_RST	O	6CD reset		L: Reset, H: Other
29	PON_5V	O	AVR control (Audio, MECHA)		L: Power ON, H: OFF (stable time 400m)
30	ON_REQ	I	Sie-BUS ON request		L: System ON request
31	SYS_ON	O	Sie-BUS ON output		L: System ON
32	SYS_OFF	O	Sie-BUS OFF output		L: System OFF
33	BUS_STBY	O	BUS_IC standby control		H: System ON
34	RESET		System reset input		L: Reset, Reset voltage: 4.2V
35,36	XT1, XT2		Sub system clock oscillator terminal		Not used
37	REGC				
38,39	X2, X1		Main system clock oscillator terminal		12.582MHz
40	VSS	-	GND potential		
41	VDD	-	5V potential		
42	CLKOUT		Not used		
43	HARD_RESET	O	Hardware reset output		H: Reset, L: Other

MICROCOMPUTER'S TERMINAL DESCRIPTION

Pin No.	Pin Name	I/O	Application	Truth Value Table	Processing Operation Description
44	P_STBY	O	P-AMP standby control		L: STAND-BY, H: Other
45	P_MUTE	O	P-AMP mute control		L: MUTE, H: Other
46	P_SVR	O	For P-AMP discharge		L: Normally, H: Discharging
47	SRS_MODE1	O	SRS-WOW mode selection 1	③	SRS_FOCUS ON: H
48	SRS_MODE2	O	SRS-WOW mode selection 2	③	SRS_TruBass ON: H
49	SRS_MODE3	O	SRS-WOW mode selection 3	③	SRS_3D-Stereo ON: H
50	DC/DC_PRO	I	Filament power supply output short detection		H: Normally, With L 100ms x 10_1s, set DC/DC_CON to OFF and write the log into EEPROM.
51	ANT_CON	O	ANT AMP power supply control		H: ACC ON, L: Other
52	TUN_DIVER	O	FM diversity antenna control (M type only)		H (OFF): In test mode or L (ON): Switch (initial: H) L (ON): In normal mode
52	NC	O	Not used (In other than M type)		Output H (OFF) fixed (After TUNER start up)
53	PON_AM	O	AM power supply control		H: AM, L: Other
54	TUN_IFC	I	F/E IFC OUT input terminal		H: Station found, L: Station not found
55	DC/DC_CON	O	DC/DC power supply control		DC/DC ON: H
56	VOL_MUTE	O	E_VOL MUTE output		MUTE ON with High (IC terminal=Low)
57	SRS_MUTE	O	MUTE output for SRS		SRS_MUTE ON: L
58	BVDD		5V potential		
59	BVSS		GND potential		
60	IGN_DET_CON	O	IGN detection operation check		H: IGN detected, L: Other
61,62	NC	O	Not used		Not used
63~65	TYPE1~TYPE3	I	Destination setting terminal 1~3	①	Refer to the truth value table
66	AUX_DET	I	AUX detection		H: AUX detected (Can be detected after PON stabilized)
67	TUN_AFS	O	Constant switching when noise detected (E type only)		L: In AF search, H: Other
67	NC	O	Not used (In other than E type)		Output H (other) fixed (while TUNER on)
68	CDX_MUTE	I	6CD mute request		H: Mute request from 6CD, L: Other
69	CDX_DDCNT	I	6CD servo power supply ON request		H: ON request from 6CD, L: Other
70	CDX_STM	I	6CD communication request input		L: Communication request to 6CD, H: Other
71	CDX_ACC	O	6CD ACC		H: 6CD on, L: Other
72,73	TYPE4, TYPE5	I	Vehicle yearly revision setting terminal 1, 2	①	L: A06 audio
74	AVDD		5V potential		
75	AVSS		GND potential		
76	AVREF		A/D port reference voltage input		
77	RDS_QUAL	I	RDS quality (E type only)		RDS quality
77	NC	I	Not used (In other than E type)		Input Hi-Z
78	RDS_DATA	I	RDS data (E type only)		RDS data input
78	NC	I	Not used (In other than E type)		Input Hi-Z

MICROCOMPUTER'S TERMINAL DESCRIPTION

Pin No.	Pin Name	I/O	Application	Truth Value Table	Processing Operation Description
79	REMOCON	I	Vehicle satellite switch input	④	Resistance dividing vehicle remote control
80	NC	I	Not used		Not used
81	DIAG	I	Terminal for test mode		L: Test mode, H: Normal
82	P_DCERR_DET	I	DC offset detection		At 1.6V or higher and 100ms x 20=2s Offset detection
83	NC	I	Not used		Not used
84	IGN_DET	I	IGN detection		H: IGN ON, L: IGN OFF
85	RDS_NOISE	I	FM noise detection (E type only)		
85	NC	I	Not used (In other than E type)		Input Hi-Z
86	TUN_SMETER	I	S meter voltage input		
87,88	NC	I	Not used		Not used
89	SP_REQ_S	O	System μ -com \rightarrow Panel μ -com request		H: ON, L: OFF
90	SP_REQ_P	I	Panel μ -com \rightarrow System μ -com request		H: ON request
91	ACC_DET	I	ACC detection		L: ACC ON, H: ACC OFF, Detected voltage: 8.5V
92	OFF_REQ	I	Sie-BUS OFF request		L: System OFF request
93	BU_DET	I	BU detection		L: BU ON, H: BU OFF (at momentary power down), Detected voltage: 8.5V
94	SP_RST	O	Reset to panel μ -com		H: Normal, L: Reset, Immediately after reset, when communication reset occurs, RESET.
95	SP_BKUP	O	Voltage down detection output to panel μ -com		L: Voltage down, H: Normal
96	RDS_CLK	I	RDS clock (E type only)		RDS clock
96	NC	O	Not used (In other than E type)		Output L fixed
97	CDX_DSTM	I	6CD data input		Communication speed 250kHz
97	FLASH_SI	I	Flash writing data input		
98	CDX_DMTS	O	6CD data output		Communication speed 250kHz
98	FLASH_SO	O	Flash writing data output		
99	CDX_SCK	I	6CD clock input		Communication speed 250kHz
99	FLASH_CLK	I	Flash writing clock input		
100	SP_DATA_P	I	Panel μ -com \rightarrow System μ -com data output		UART 19200bps

Truth Value Table

① Point of destination setting terminal

TYPE1 (63pin)	TYPE2 (64pin)	TYPE3 (65pin)	TYPE4 (72pin)	TYPE5 (73pin)	Destination
L	L	L	L	L	GX204JE,JH
L	L	H	L	L	GX204KE,KH
L	H	L	L	L	GX204RE
L	H	H	L	L	-
H	L	L	L	L	-
H	L	H	L	L	GX204SE
H	H	L	L	L	GX204LE
H	H	H	L	L	-

MICROCOMPUTER'S TERMINAL DESCRIPTION

③ SRS mode switching

SRS_MODE1 47pin	SRS_MODE2 48pin	SRS_MODE3 49pin	Mode
L	L	L	OFF
L	L	H	3D-Stereo
L	H	L	TruBass
H	L	L	FOCUS
H	H	H	WOW

④ REMOCON voltage table

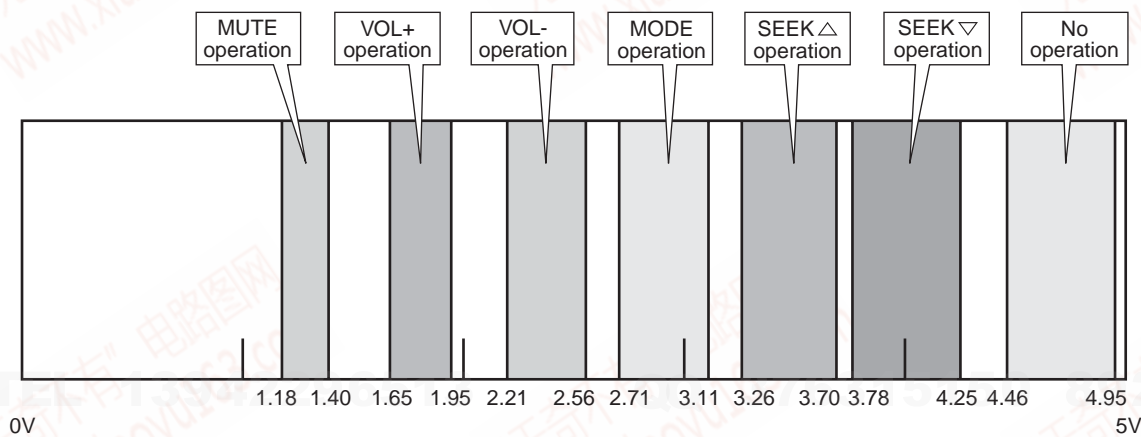

● PANEL (AUDIO) MICROCOMPUTER: MB90562A-419E (X34-401: IC501)

Pin No.	Pin Name	I/O	Application	Processing Operation Description
1	NC	O	Not used	Output L fixed
2~5	KR3~KR6	I	Key scan pulse input terminal	
6~9	KS1~KS4	O	Key scan pulse output terminal	
10,11	NC	O	Not used	Output L fixed
12	AVCC		Power supply input for A/D converter	VCC
13	AVR		REF voltage input for A/D converter	SW_5V potential
14	AVSS		GND connection for A/D converter	GND potential
15	SP_DATA_S	I	Data from system μ-com → panel μ-com output	Communication speed 19200bps, 50ms interval
16	SP_DATA_P	O	Data from panel μ-com → system μ-com output	Communication speed 19200bps, 20ms interval
17	SP_REQ_P	O	Request from panel μ-com → system μ-com	
18	SP_BKUP	I	Inputs voltage reduction from system μ-com detection	L: Momentary power down detected, H: Normal
19	MD0	I	For FLASH ROM writing	Hi: Normal mode, Lo: FLASH writing mode
20	SP_RST	I	Reset input from system μ-com	Reset request from system μ-com Lo
21	MD1	I	For FLASH ROM writing	Hi: Normal and FLASH writing mode, Lo: Not set-up

MICROCOMPUTER'S TERMINAL DESCRIPTION

Pin No.	Pin Name	I/O	Application	Processing Operation Description
22	MD2	I	For FLASH ROM writing	Hi: FLASH writing mode, Lo: Normal mode
23	X0		μ -com clock oscillator	4.0MHz (ceramic oscillator)
24	X1		μ -com clock oscillator	4.0MHz (ceramic oscillator)
25	VSS1		Power supply GND	GND potential
26	P00	I	FLASH writing method setting	
27	P01	I	FLASH writing method setting	
28	NC	O	Not used	Output L fixed
29	SW_5V	O	SW series 5V power supply	Lo: ON, Hi: OFF
30	POWER	I	POWER	Lo: ON, Hi: OFF
31	ENC_DW	I	Rotary encoder SW (B phase wave form)	Port monitoring of pulse with 1ms cycle timer
32	ENC_UP	I	Rotary encoder SW (A phase wave form)	Port monitoring of pulse with 1ms cycle timer
33	NC	O	Not used	Output L fixed
34	SP_REQ_S	I	Request from system μ -com \rightarrow panel μ -com	Hi: ON, Lo: OFF
35~38	NC	O	Not used	Output L fixed
39	KR7	I	Key scan pulse input terminal	
40,41	KR2, KR1	I	Key scan pulse input terminal	
42	NC	O	Not used	Output L fixed
43	FL_BLK	O	FL data blanking output terminal (FL tube luminance adjustment)	Adjusts luminance with duty ratio. Hi: OFF, Lo: ON
44~47	NC	O	Not used	Output L fixed
48	SDA	I/O	Serial data for E2PROM	Input/output to E2PROM
49	SCL	O	Serial clock for E2PROM	Output to E2PROM
50	VSS2		Power supply GND	GND potential
51	NC	O	Not used	Output L fixed
52	TYPE1	I	Destination setting	H: Left-hand steering, L: Right-hand steering
53	NC	O	Not used	Output L fixed
54	BRIGHT	I	Change logic when brightness changes	Operation: When "H", bright data is finalized at UART
55	HTR	I	For determining bright terminal valid/invalid	Operation: When "H", bright terminal is valid
56	NC	O	Not used	Output L fixed
57	VCC		Power supply input	Bu5V potential
58	C	-	Voltage stabilizing process terminal	0.1 μ F condenser connection
59	NC	O	Not used	Output L fixed
60	FL_SO	O	FL data output terminal	
61	FL_CLK	O	FL clock output terminal	
62	FL_LAT	O	FL data latch control terminal	
63,64	NC	O	Not used	Output L fixed

MICROCOMPUTER'S TERMINAL DESCRIPTION

● PANEL (HEATER CONTROL) MICROCOMPUTER: MB89537A1010E (X34-405: IC1)

Pin No.	Pin Name	I/O	Application	Processing Operation Description
1	SH_DATA_H	O	HTR-C μ -com \rightarrow System μ -com data output	Communication speed: 4800bps
2	SH_DATA_S	I	System μ -com \rightarrow HTR-C μ -com data output	Communication speed: 4800bps
3	MOD2	I	Memory access mode setting input terminal for when FLASH	Always L input
4	TYPE1	I	Destination setting	4V or higher: Left-hand steering, 2V or lower: Right-hand steering
5	TYPE2	I	Destination setting	4V or higher: SINGLE, 2V or lower: DUAL
6	TYPE3	I	Destination setting	4V or higher: 15~29°C, 2V or lower: 18~32°C
7~11	NC	O	Not used	Output L fixed
12	AVCC	-	A/D converter power supply terminal	
13	AVR	-	A/D converter standard voltage input terminal	
14	AVSS	-	A/D converter power supply terminal	
15	NC	I	Not used	Input fixed
16	ACC_DET	I	ACC detection	L: ACC ON, H: ACC OFF, Detected voltage: 8.9V
17~19	NC	I	Not used	Input fixed
20	RST	-	Reset input terminal	L: Reset
21	MD0	-	Input terminal for memory access mode setting	H: When writing FLASH μ -com, L: Other
22	MD1	-	Input terminal for memory access mode setting	H: When writing FLASH μ -com, L: Other
23	X0	-	Oscillator connection terminal	12.288MHz
24	X1	-	Oscillator connection terminal	12.288MHz
25	VSS	-	Power supply terminal	
26,27	NC	O	Not used	Output L fixed
28	HTR	O	Terminal for determining bright terminal valid/invalid	Start operating when the heater control μ -com IGN ON, and at the point when the air-conditioner data is finalized at UART, ON. H: ON, L: OFF
29	BRIGHT	O	Output terminal for bright information from vehicle	At the point when the bright data is finalized at UART, ON. H: ON, L: OFF
30	FLASH_MOD	I	Input terminal for FLASH writing setting	Always L input
31	R-DEF	O	Rear DEF indicator control terminal	LED luminance control by PWM control, 2 steps brightness, 4ms cycle PWM
31	P22	I	Input terminal for FLASH writing setting	H: When writing FLASH μ -com
32	F-DEF	O	Front DEF indicator control terminal	LED luminance control by PWM control, 2 steps brightness, 4ms cycle PWM
33	KEY_DET	O	Panel key operation check	When key or encoder is input, "H" is output at 100ms (in test mode only)
34	ENC_L3	I	Rotary encoder (left) pulse count input terminal	
35	ENC_L2	I	Rotary encoder (left) pulse count input terminal	
36	ENC_L1	I	Rotary encoder (left) pulse count input terminal	
37	ENC_R3	I	Rotary encoder (right) pulse count input terminal	

MICROCOMPUTER'S TERMINAL DESCRIPTION

Pin No.	Pin Name	I/O	Application	Processing Operation Description
38	ENC_R2	I	Rotary encoder (right) pulse count input terminal	
39	ENC_R1	I	Rotary encoder (right) pulse count input terminal	
40,41	KR3, KR2	I	Key scan pulse input terminal	
41	P10	I	Input terminal for FLASH writing setting	H: When writing FLASH μ -com
42,43	KR1, KR0	I	Key scan pulse input terminal	
44~46	KS2~KS0	I/O	Key scan pulse output terminal	
47	NC	O	Not used	Output L fixed
48	SCL	I/O	Outputs clock to E2PROM	
49	SDA	I/O	Outputs serial data to E2PROM	
50	FLASH: [C] MASK: [NC]	-	In FLASH products, connect 0.1 μ F, and in MASK products, NC (no connection)	
51,52	NC	O	Not used	Output L fixed
53	HTR_ECU_TX	O	HTR-C μ -com \rightarrow HTR-C ECU	4800bps
54	HTR_ECU_RX	I	HTR-C ECU \rightarrow HTR-C μ -com	4800bps
55	FL_BLK	O	FL display tube blank control terminal	FL display tube luminance control by PWM control H: Blank (display OFF)
56	ILL_DET-	I	ILL- detection (pulse input)	
57	VCC	-	Power supply terminal	
58	ILL_DET+	I	ILL+ detection	ILL ON: H
59	FL_FIL_ON	I/O	FL tube filament power supply control SW	Hi-Z: OFF, L: ON. Timing is the same as DC_DC_ON
60	FL_LAT	O	FL data latch control terminal	Execute output OFF count while not displayed.
61	FL_CLK	O	FL clock output terminal	Sync clock output while VFD serial communication
61	FLASH_CLK	O	Clock output to ROM writer (For FLASH μ -com only)	Clock transmission to ROM writer (communication speed is dependent on ROM writer)
62	FL_SO	O	FL data output terminal	Display data transmission to VFD
62	FLASH_SO	O	Data output to ROM writer (For FLASH μ -com only)	Data transmission to ROM writer (communication speed is dependent on ROM writer)
63	FLASH_SI	I	Data input from ROM writer (For FLASH μ -com only)	Data reception from ROM writer (communication speed is dependent on ROM writer)
63	NC	O	For mask μ -com, Not used	Output L fixed
64	DC_DC_ON	I/O	FL tube power supply control terminal	Hi-Z: ON, L: OFF

PC BOARD (COMPONENT SIDE VIEW)

SWITCH UNIT
X34-405x-xx (J74-1712-12)

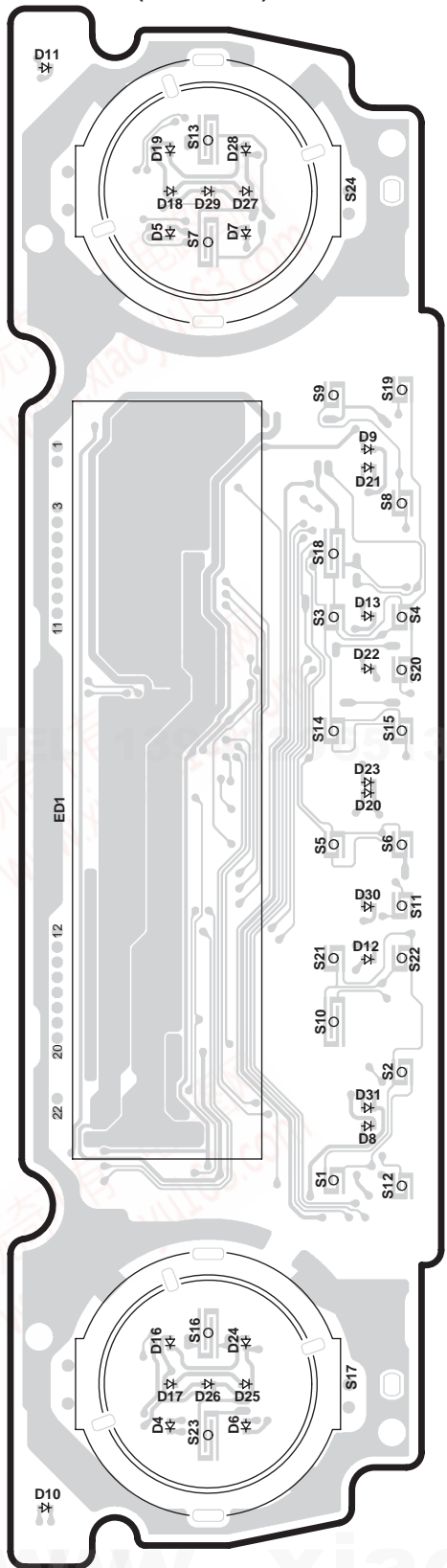

(FOIL SIDE VIEW)

SWITCH UNIT
X34-405x-xx (J74-1712-12)

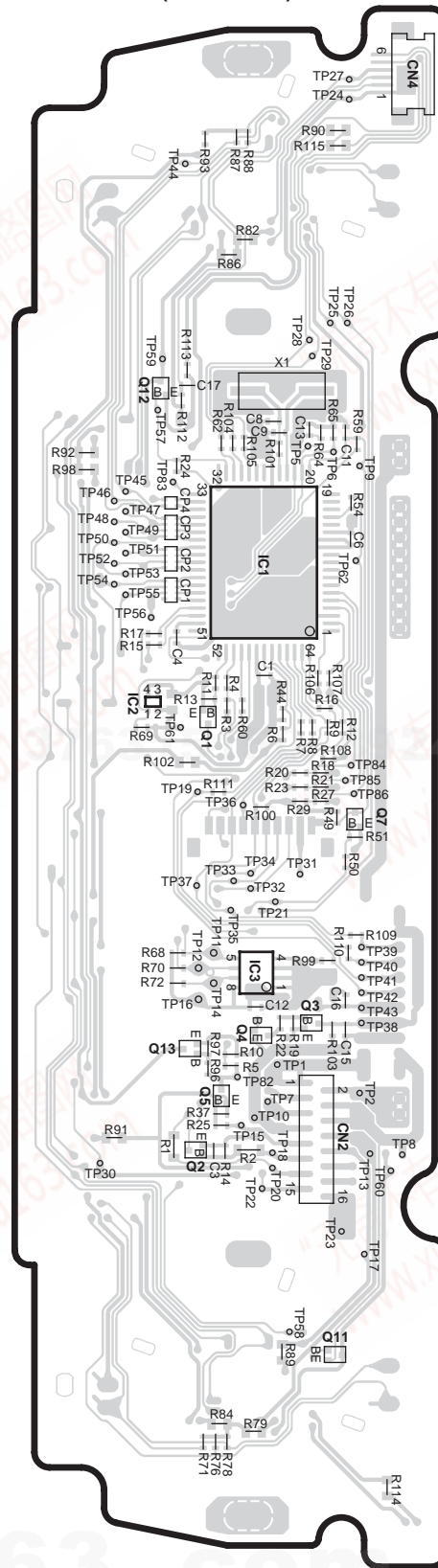

X34-405x-xx

Ref. No.	Address
IC1	3D
IC2	4C
IC3	5D
Q1	4D
Q2	5D
Q3	5D
Q4	5D
Q5	5D
Q7	4D
Q11	6D
Q12	3C
Q13	5C

Refer to the schematic diagram for the values of resistors and capacitors.

PC BOARD (COMPONENT SIDE VIEW)

SYNTHESIZER UNIT
X14-967x-xx (J74-1710-12)

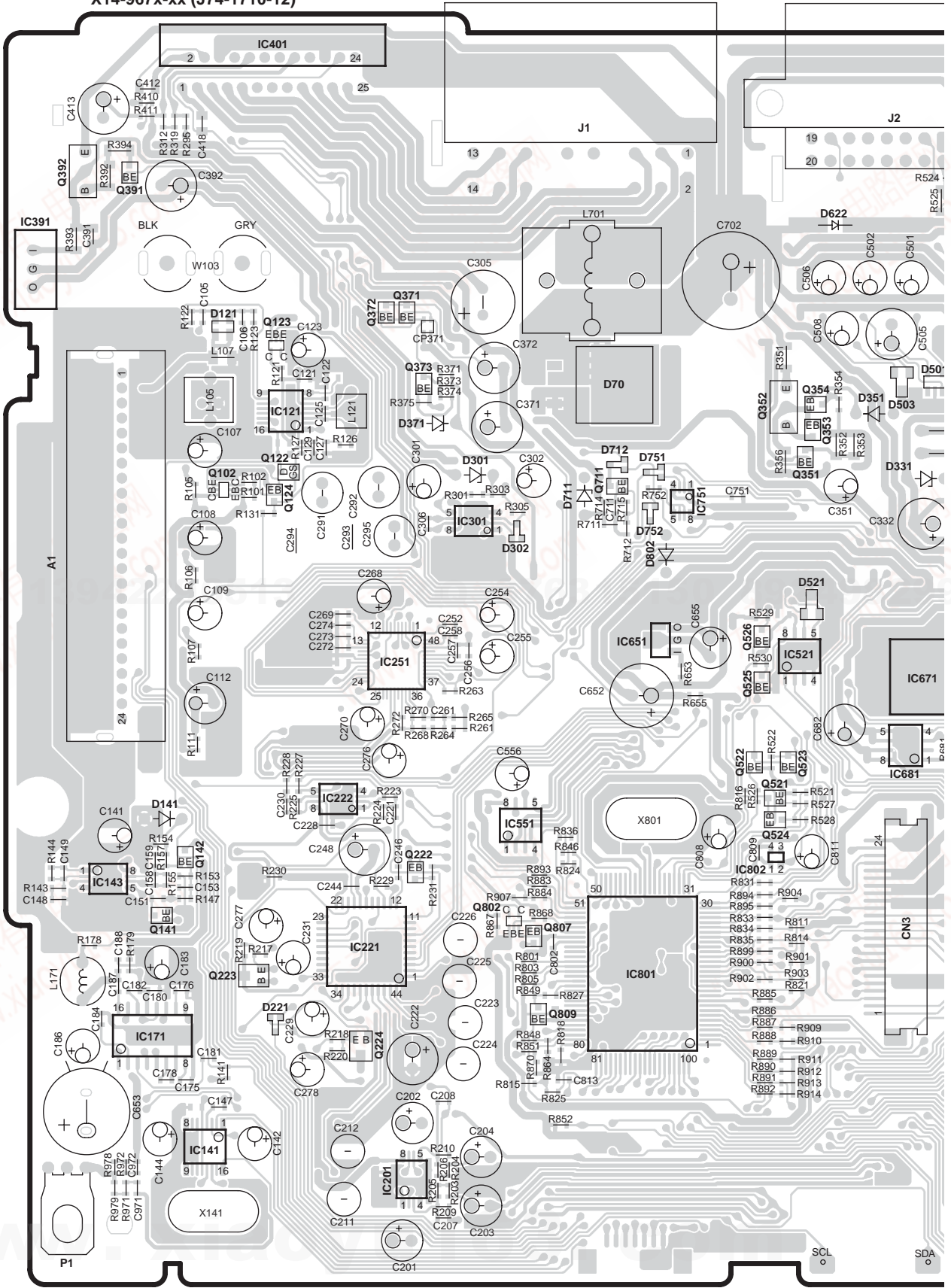

QQ 376315150

892498299

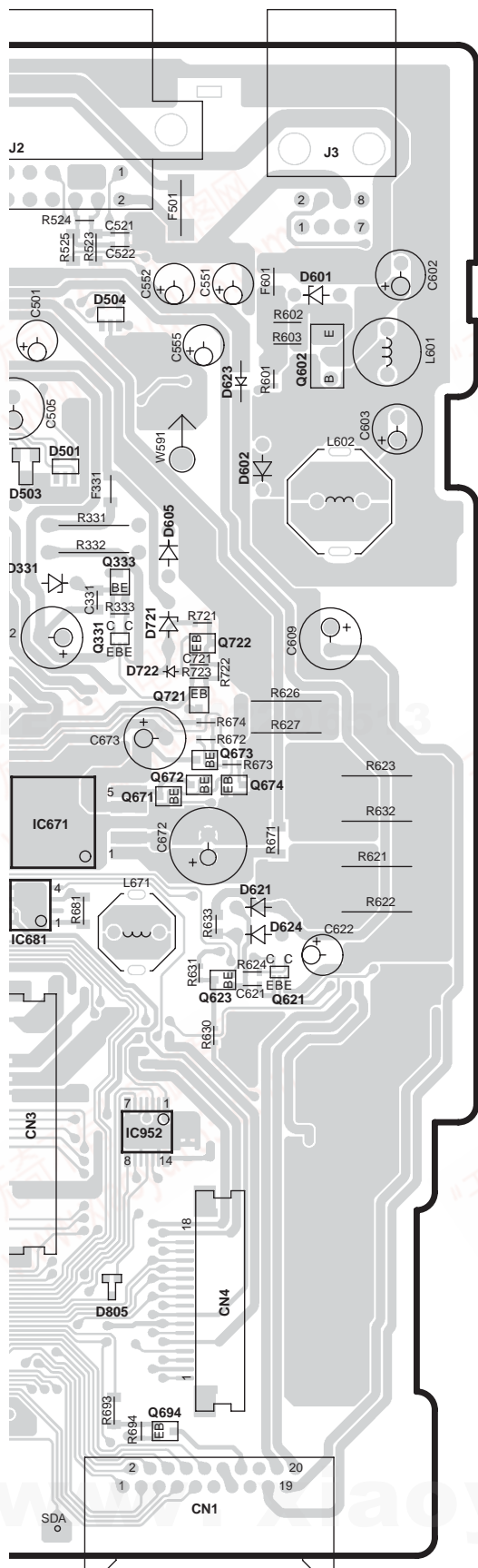

X14-967x-xx

Ref. No.	Address	Ref. No.	Address
IC121	3H	Q333	3K
IC141	6G	Q351	3J
IC143	5G	Q352	3J
IC171	6G	Q353	3J
IC201	7H	Q354	3J
IC221	6H	Q371	3H
IC222	5H	Q372	3H
IC251	4H	Q373	3H
IC301	4H	Q391	2G
IC391	2F	Q392	2G
IC401	2G	Q521	5J
IC521	4J	Q522	5J
IC551	5I	Q523	5J
IC651	4I	Q524	5J
IC671	4K	Q525	4J
IC681	5J	Q526	4J
IC751	4I	Q602	3L
IC801	6I	Q621	5L
IC802	5J	Q623	5K
IC952	6K	Q671	4K
Q102	3G	Q672	4K
Q122	3G	Q673	4K
Q123	3G	Q674	4K
Q124	4H	Q694	7K
Q141	5G	Q711	4I
Q142	5G	Q721	4K
Q222	5H	Q722	4K
Q223	6G	Q802	5H
Q224	6H	Q807	5I
Q331	4K	Q809	6I

Refer to the schematic diagram for the values of resistors and capacitors.

PC BOARD (FOIL SIDE VIEW)

SYNTHESIZER UNIT
X14-967x-xx (J74-1710-12)

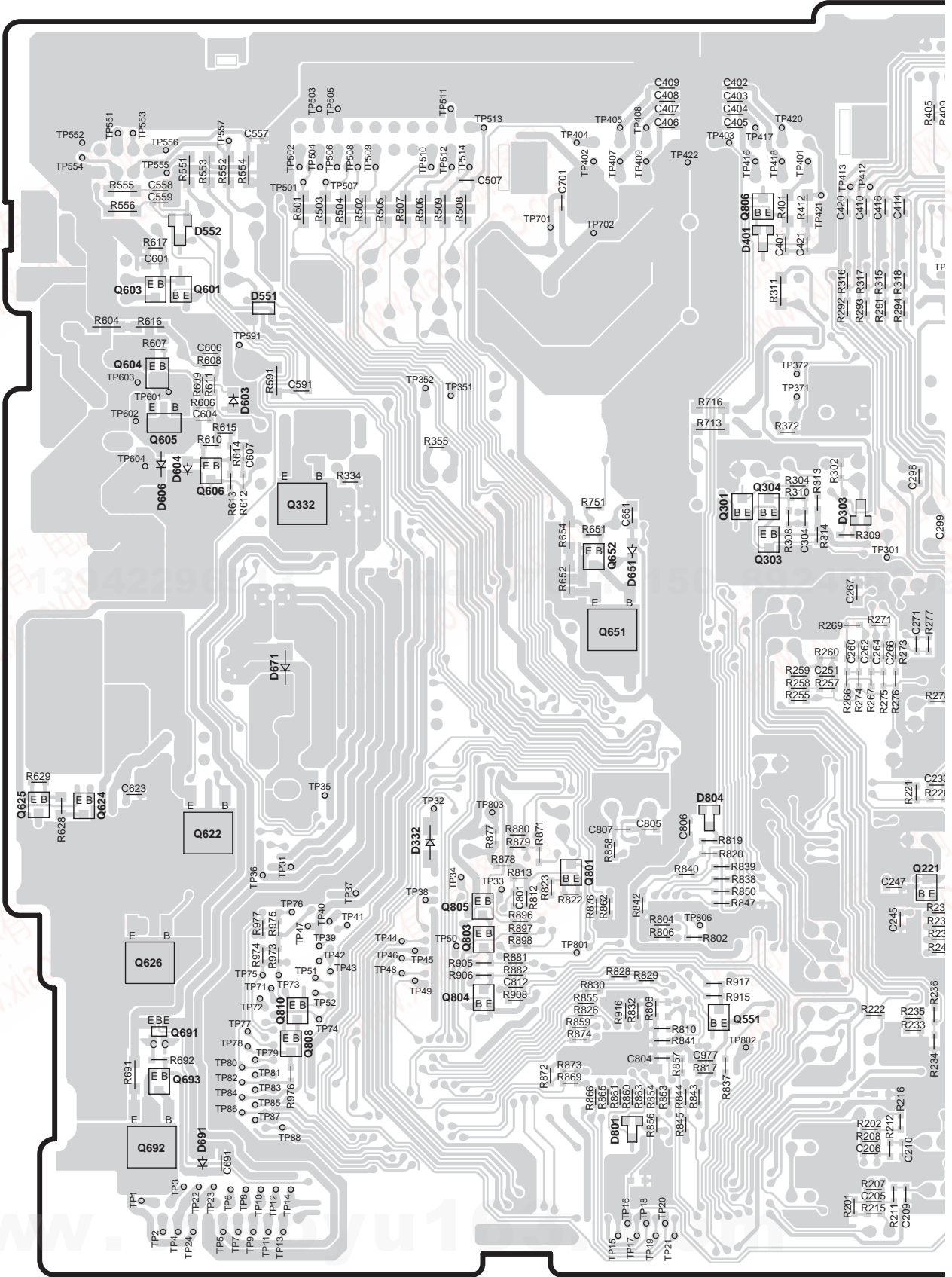

QQ 376315150

892498299

POWER SUPPLY UNIT X00-4100-00 (J74-1713-02)

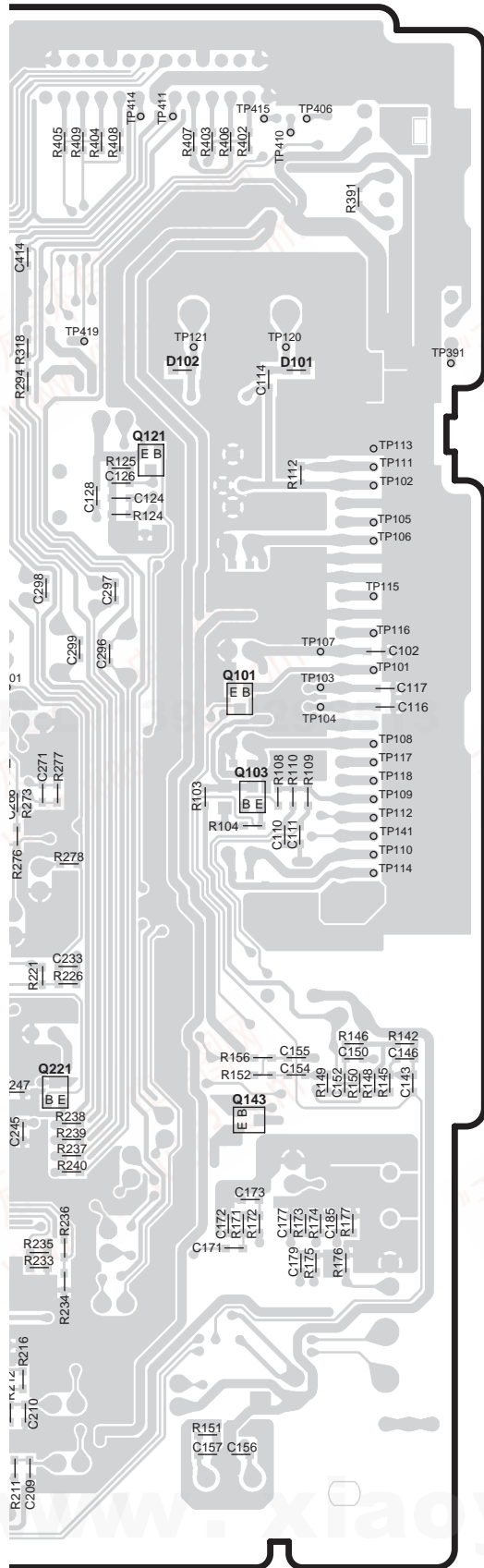

X14-967x-xx

Ref. No.	Address
Q101	4U
Q103	4U
Q121	3U
Q143	5U
Q221	5U
Q301	4S
Q303	4T
Q304	4T
Q332	4R
Q551	6T
Q601	3Q
Q603	3Q
Q604	3Q
Q605	3Q
Q606	4Q
Q622	5Q
Q624	5Q
Q625	5P
Q626	6Q
Q651	4S
Q652	4S
Q691	6Q
Q692	6Q
Q693	6Q
Q801	5S
Q803	6R
Q804	6R
Q805	5R
Q806	2T
Q808	6R
Q810	6R

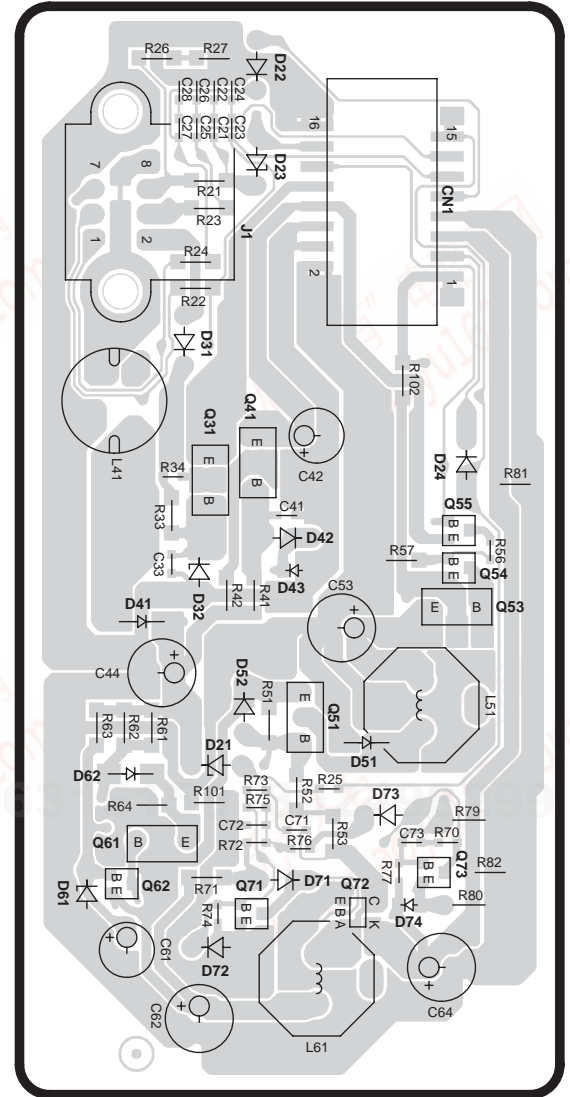

X00-4100-00

Ref. No.	Address
Q31	3X
Q41	3X
Q51	4X
Q53	3Y
Q54	3Y
Q55	3Y
Q61	4X
Q62	4X
Q71	4X
Q72	4X
Q73	4Y

Refer to the schematic diagram for the values of resistors and capacitors.

GX204KEF2/KHF2/LEF2
GX204REF2/SEF2

PC BOARD (COMPONENT SIDE VIEW)

SWITCH UNIT X34-401x-xx (J74-1711-12)

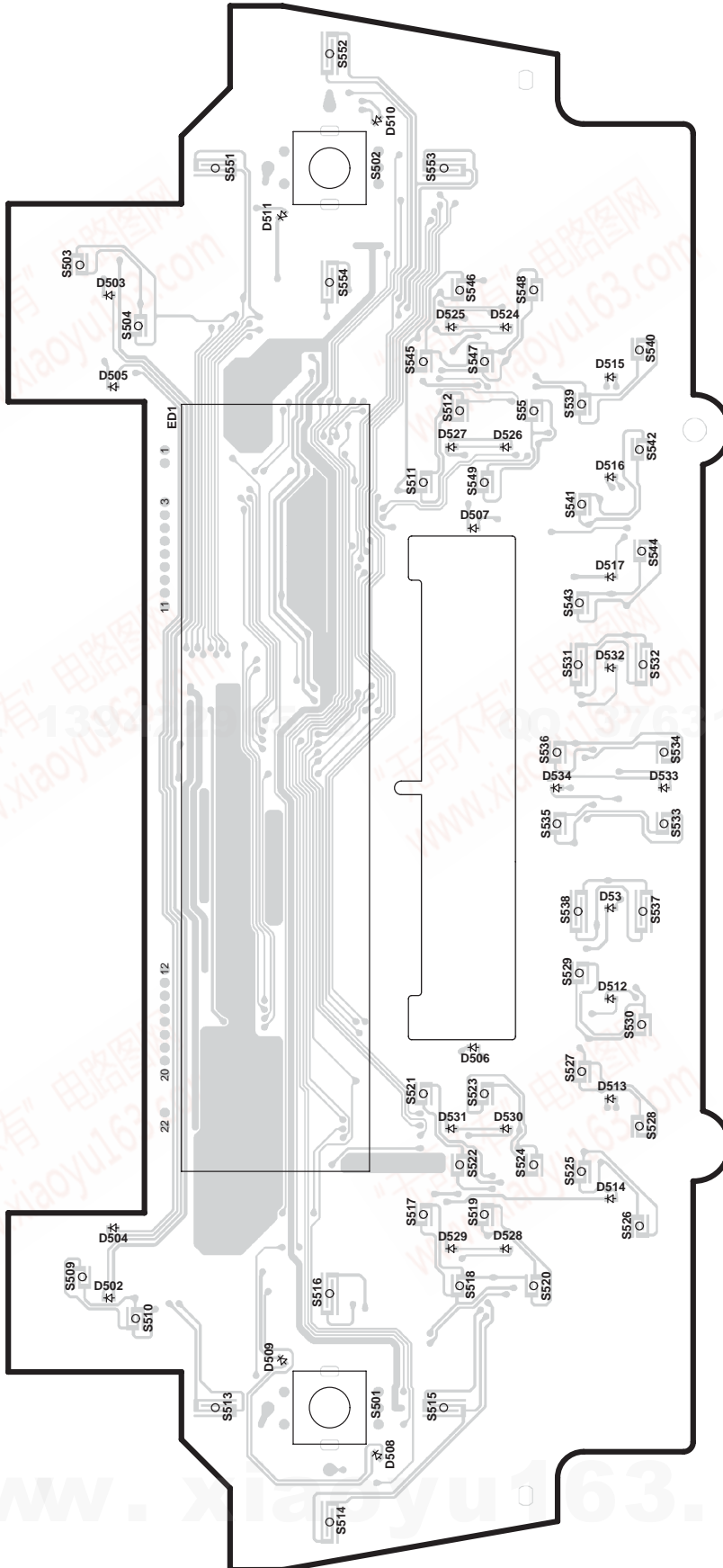

Refer to the schematic diagram for the values of resistors and capacitors.

PC BOARD (FOIL SIDE VIEW)

SWITCH UNIT X34-401x-xx (J74-1711-12)

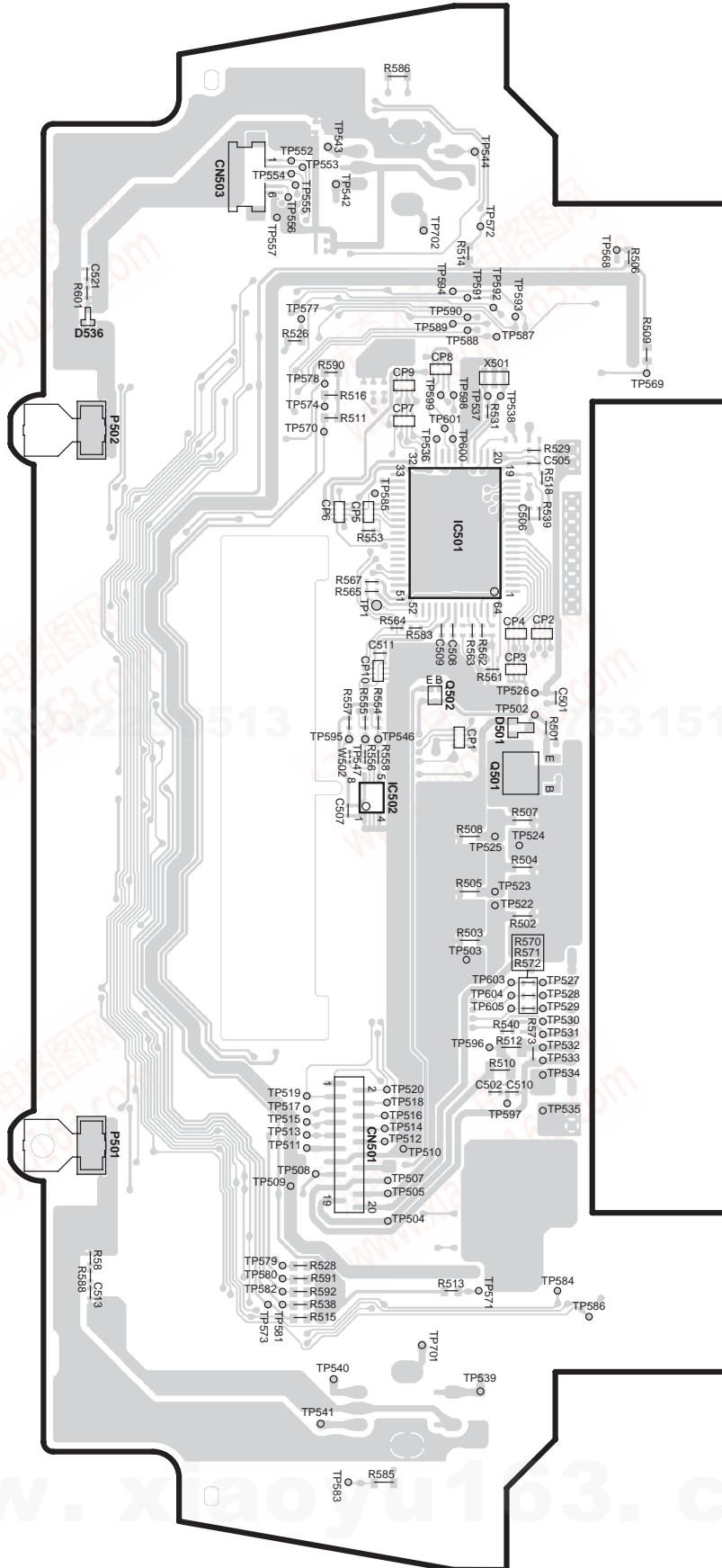

X34-401x-xx

Ref. No.	Address
IC501	3AG
IC502	4AF
Q501	4AG
Q502	4AG

Refer to the schematic diagram for the values of resistors and capacitors.

GX204KEF2/KHF2/LEF2
GX204REF2/SEF2

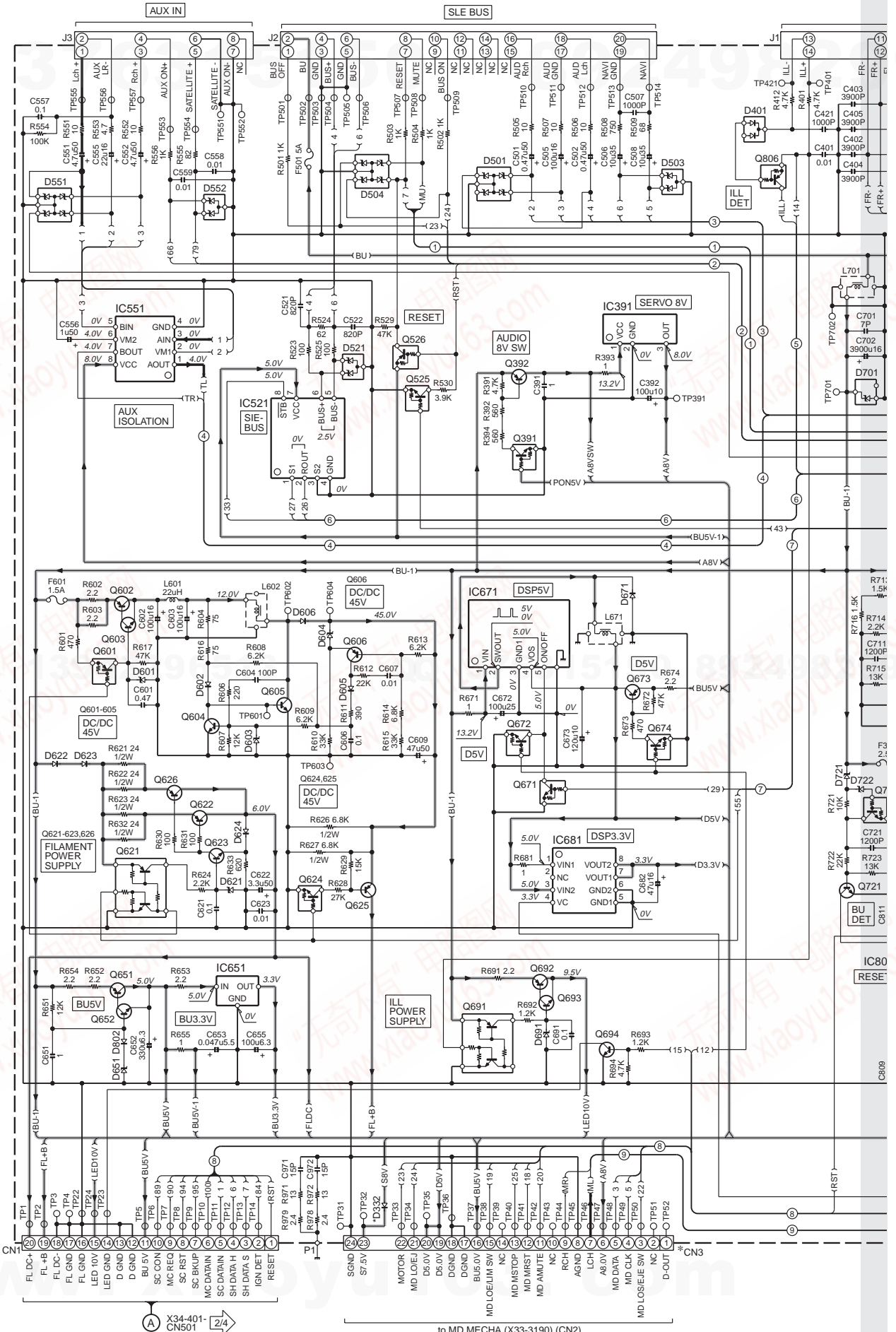

to MD MECHA (X33-3190) (CN2)

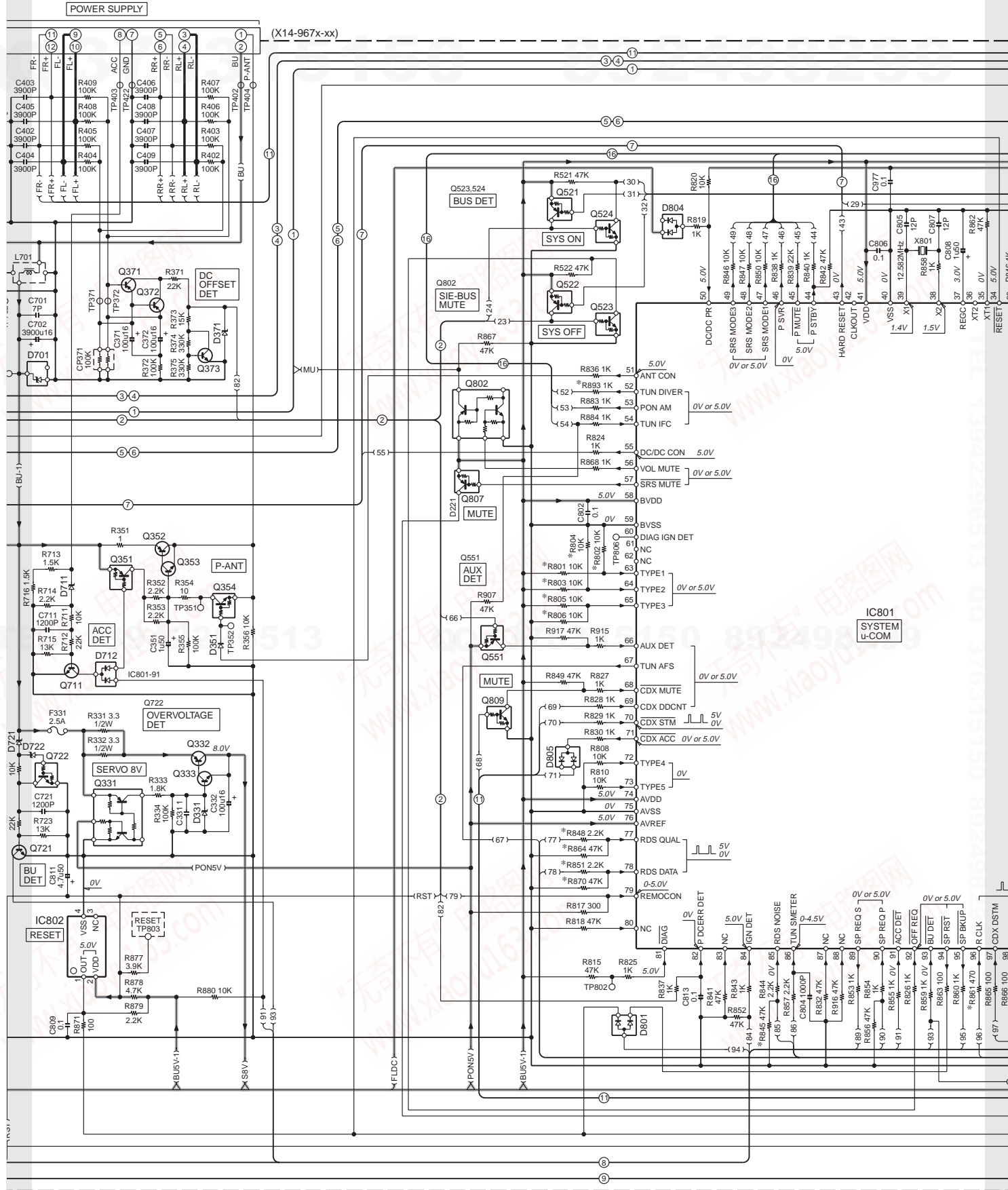

TEL 13942296513 QQ 376315150 89249829

GX204KEF2/KHF2/LEF2
GX204REF2/SEF2

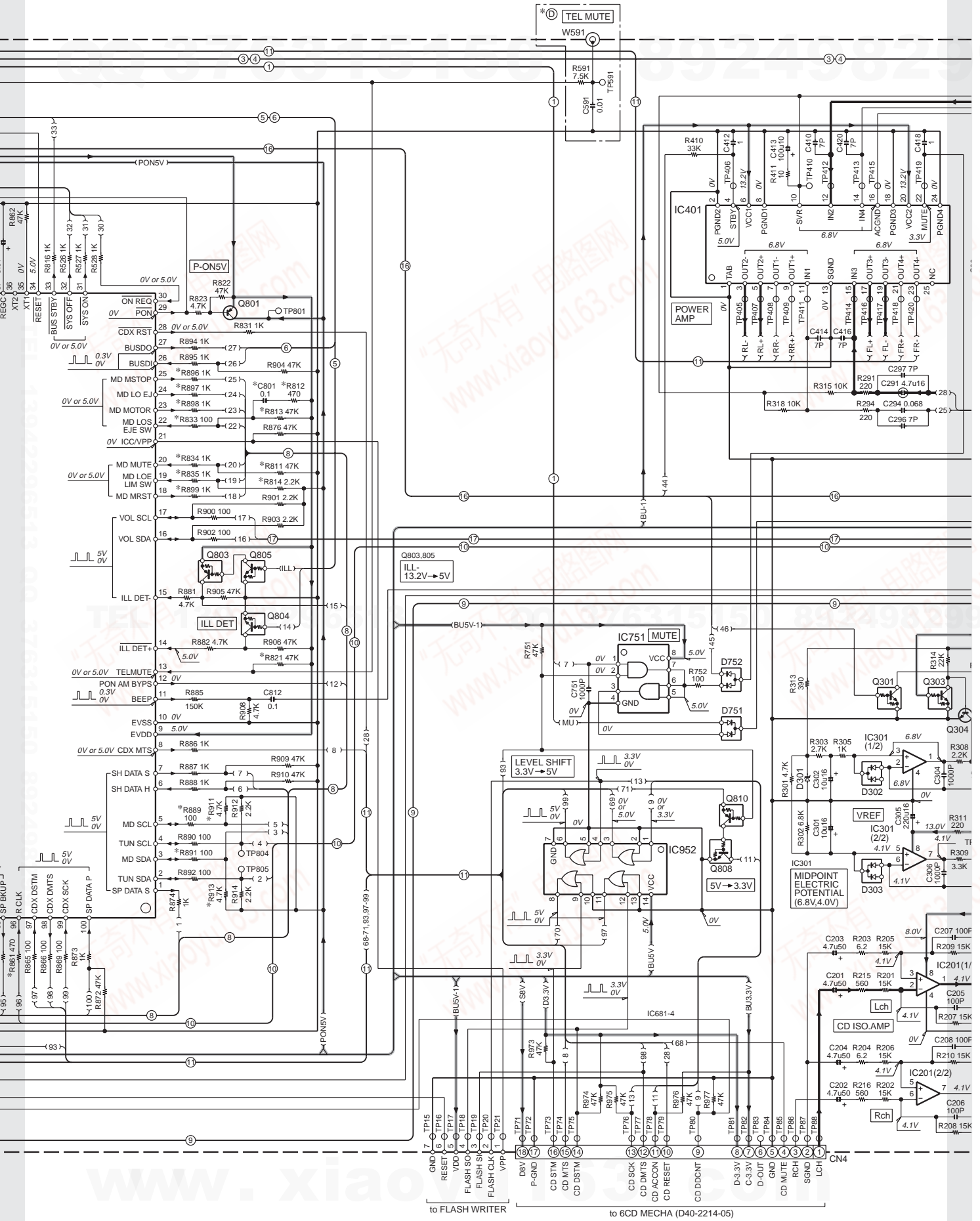

GX204KEF2/KHF2/LEF2 GX204REF2/SEF2

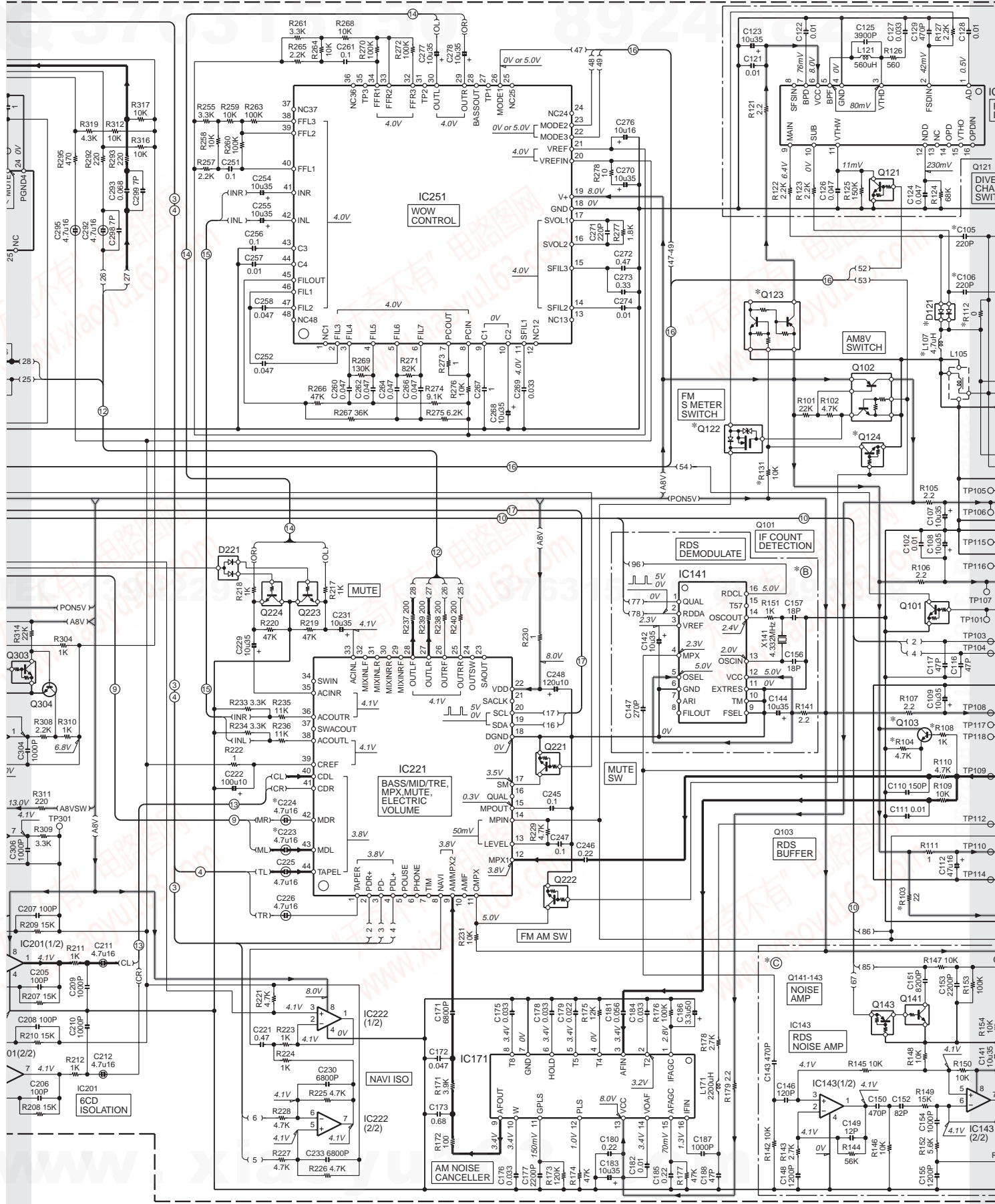

GX204KEF2/KHF2/LEF2
GX204REF2/SEF2

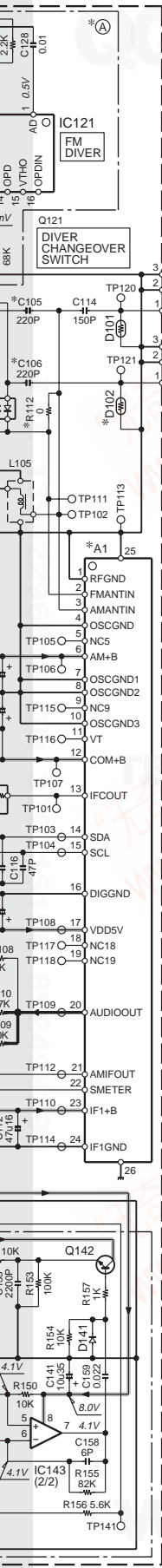

- IC121 : TA2083AFNG
 - IC141 : E-TDA7479AD
 - IC143,201,222,301
 - IC171 : NJM4565V-ZB
 - IC221 : HA12181FP-E
 - IC251 : E-TDA7406
 - IC391 : NJM2195FJ1-ZA
 - IC401 : BA08CC0T
 - IC401 : E-TDA7384A
 - IC521 : HA12187FP-E
 - IC551 : BA3121F
 - IC651 : SI-3033LUSNF
 - IC671 : SI-8050JDNF
 - IC681 : SI-3033LSANF
 - IC751 : TC7W02FU-F
 - IC801 : 703037HYGM04A
 - IC802 : S-80842CNB-G
 - IC952 : TC74VHCT32AFT
- Q101,523,524,671,672,722,804,805
 - Q102 : DTC144EUA
 - Q103 : UMF5N
 - Q103,142,304,333,353,373,603,623,652,693,711,721 : 2SC4081
 - Q121,525,624
 - Q122 : DTC114EUA
 - Q122 : 2SK3018
 - Q123,331,621,691,802
 - Q124 : UMC2N
 - Q124,221,222,303,808,809 : DTC124EUA
 - Q141 : DTC114TUA
 - Q143,521,522,551,601,807,810 : DTA124EUA
 - Q223,224 : DTC343TK
 - Q301,391,674
 - Q332,622,626,651,692
 - Q351,526,803
 - Q352 : DTA114EUA
 - Q352,392,602
 - Q354 : 2SB1443
 - Q354 : DTC143EUA
 - Q371,372,606,625,801
 - Q604 : 2SA1576A
 - Q605 : 2SC3392
 - Q673 : 2SC824
 - Q673 : 2SA1577
 - Q694 : 2SC4097
 - Q806 : DTA143EUA
- D101,102 : IMSA-6802-E
 - D121 : 1SV237-F
 - D141,351,602,605,624,802 : 1SS133
 - D221,752,804,805
 - D301,711,721
 - D302,303,401,712,751
 - D331 : DAN202U
 - D332,622,623
 - D501,504,551
 - D503,521,552
 - D601 : STZ6.8N
 - D601 : HZS12L-E(B1)
 - D603 : UDZS3.3B
 - D604 : UDZS5.6B
 - D606 : EFS9Q06
 - D621 : HZS9L-E(C3)
 - D651 : UDZS5.1B
 - D671 : RB160L-40
 - D691,722 : UDZS10B
 - D701 : ST70-27F-5072
 - D801 : RB717F

MODEL NAME	UNIT No.	C223	C106	C105	D102	D332	L107	Q103	Q102	R103	R801	R802	R804,845,864,870	R806	R805	R806	R814,814,833,835,889,891,896,899,911,913	W103
GX204KEF2	0-00	YES	YES	YES	YES	YES	YES	YES	YES	YES	YES	YES	YES	YES	YES	YES	YES	YES
GX204KHF2	0-21	YES	YES	YES	YES	YES	YES	YES	YES	YES	YES	YES	YES	YES	YES	YES	YES	YES
GX204LEF2	0-11	YES	YES	YES	YES	YES	YES	YES	YES	YES	YES	YES	YES	YES	YES	YES	YES	YES
GX204REF2	2-71	YES	YES	YES	YES	YES	YES	YES	YES	YES	YES	YES	YES	YES	YES	YES	YES	YES
GX204SEF2	2-72	YES	YES	YES	YES	YES	YES	YES	YES	YES	YES	YES	YES	YES	YES	YES	YES	YES

DTC114YUA
DTC343TK
2SA1576A

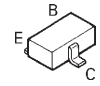

2SD1858

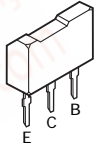

2SB1184

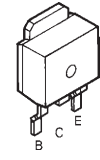

2SB1443

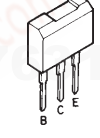

2SC4081

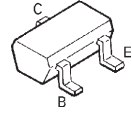

DTA114EUA
DTA124EUA
DTA143EUA
DTC114EUA
DTC124EUA
DTC144EUA

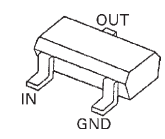

CAUTION : For continued safety, replace safety critical components only with manufacturer's recommended parts (refer to parts list).
⚠ Indicates safety critical components. To reduce the risk of electric shock, leakage-current or resistance measurements shall be carried out (exposed parts are acceptably insulated from the supply circuit) before the appliance is returned to the customer.

• DC voltages are as measured with a high impedance voltmeter. Values may vary slightly due to variations between individual instruments or/and units.

(X34-401x-xx)

1
2
3
4
5
6
7

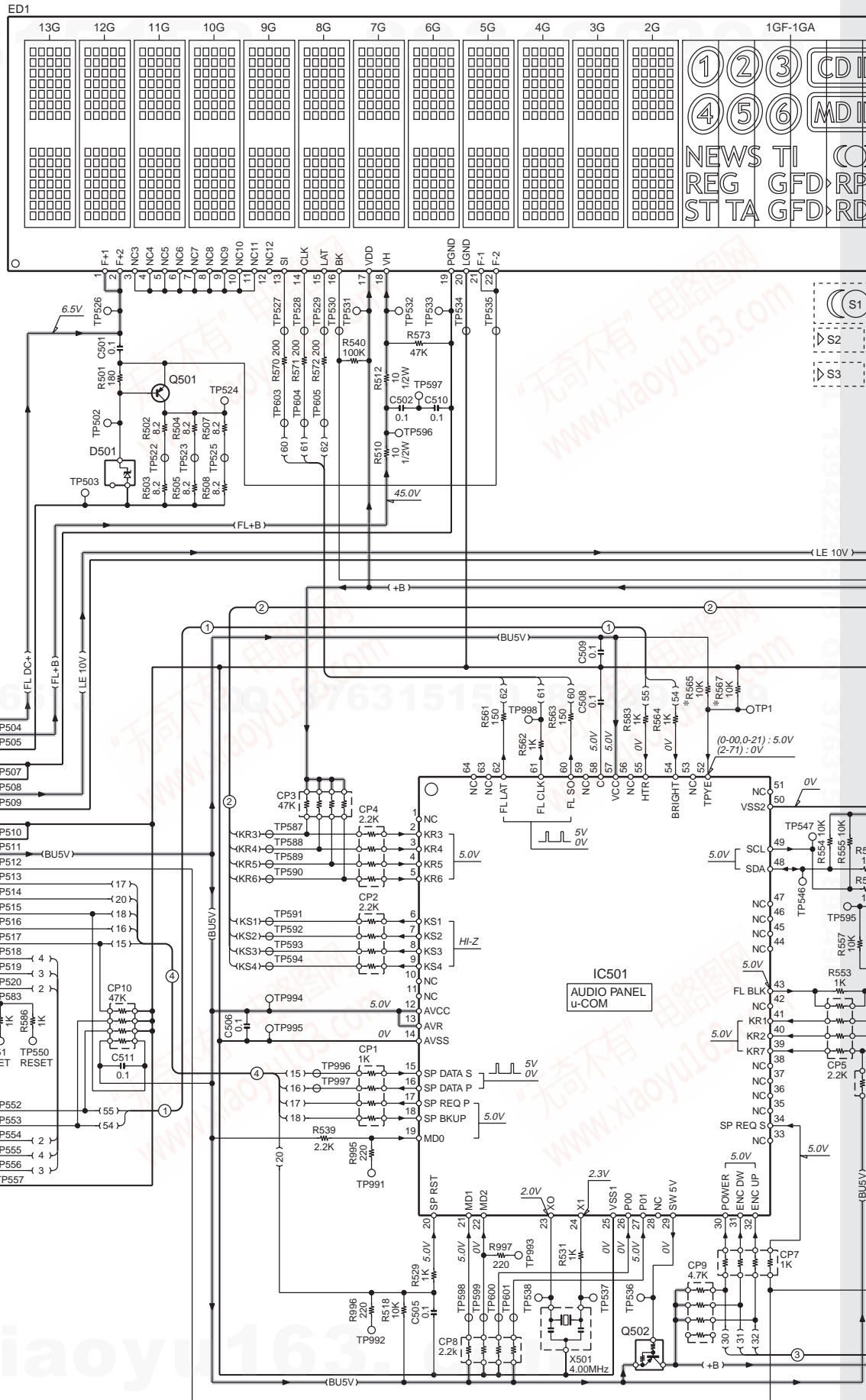

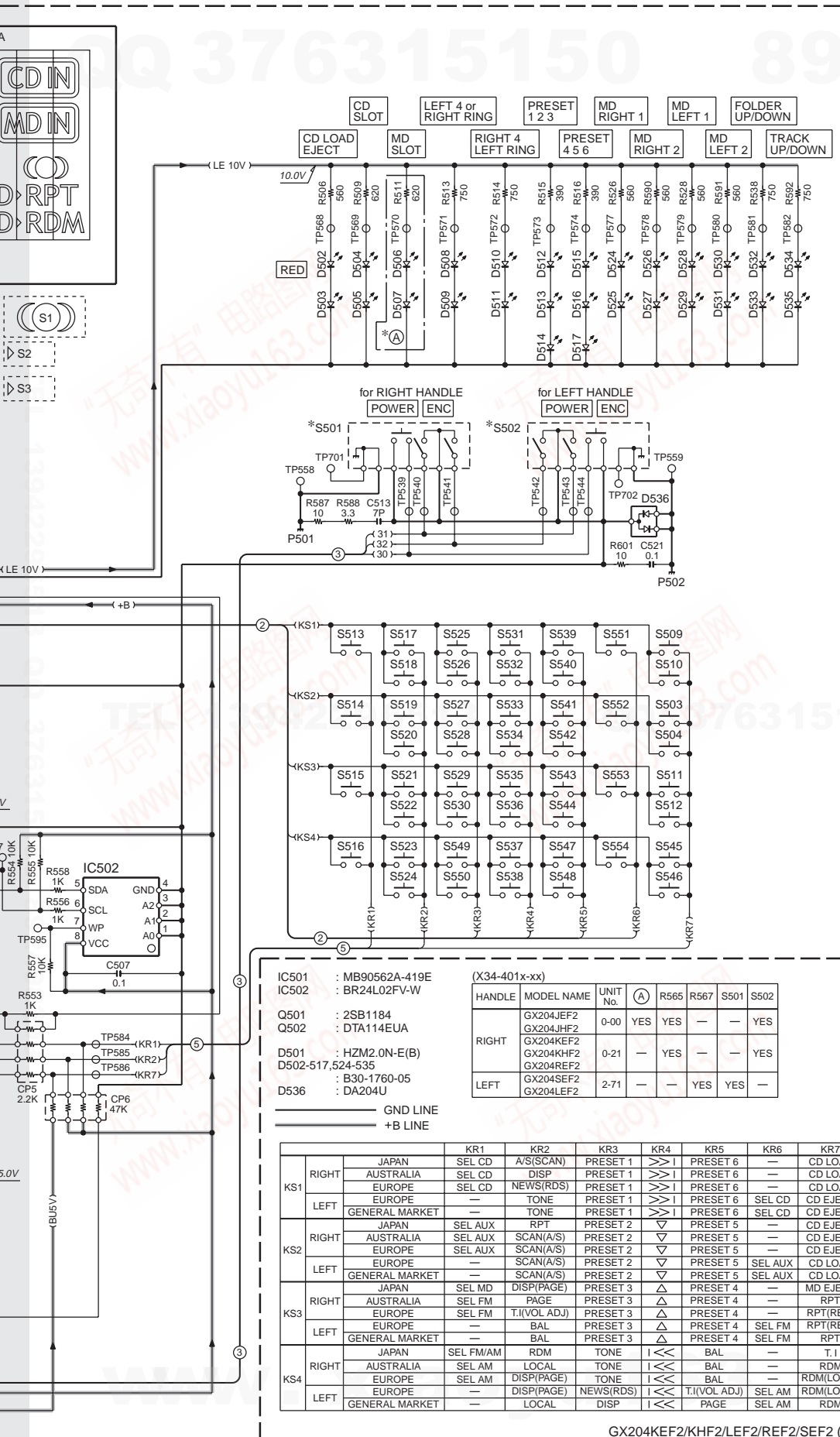

CAUTION : For continued safety, replace safety critical components only with manufacturer's recommended parts (refer to parts list).

⚠ Indicates safety critical components. To reduce the risk of electric shock, leakage-current or resistance measurements shall be carried out (exposed parts are acceptably insulated from the supply circuit) before the appliance is returned to the customer.

- DC voltages are as measured with a high impedance voltmeter. Values may vary slightly due to variations between individual instruments or/and units.

HANDLE	MODEL NAME	UNIT No.	Ⓐ	R565	R567	S501	S502
	GX204JEF2	0-00	YES	YES	—	—	YES
	GX204JHF2						
	GX204KEF2	0-21	—	YES	—	—	YES
	GX204KHF2						
	GX204REF2						
	GX204SEF2	2-71	—	—	YES	YES	—
	GX204LEF2						

KR1	KR2	KR3	KR4	KR5	KR6	KR7	
							RIGHT
KS1	JAPAN	SEL CD	A/S(SCAN)	PRESET 1	PRESET 6	—	CD LOAD
	AUSTRALIA	SEL CD	DISP	PRESET 1	PRESET 6	—	CD LOAD
	EUROPE	SEL CD	NEWS(RDS)	PRESET 1	PRESET 6	—	CD LOAD
	EUROPE	—	—	—	—	—	—
KS2	JAPAN	SEL AUX	RPT	PRESET 2	PRESET 5	—	CD EJECT
	AUSTRALIA	SEL AUX	SCAN(A/S)	PRESET 2	PRESET 5	—	CD EJECT
	EUROPE	SEL AUX	SCAN(A/S)	PRESET 2	PRESET 5	—	CD EJECT
	EUROPE	—	—	—	—	—	—
KS3	JAPAN	SEL MD	DISP(PAGE)	PRESET 3	PRESET 4	—	MD EJECT
	AUSTRALIA	SEL FM	PAGE	PRESET 3	PRESET 4	—	RPT
	EUROPE	SEL FM	T.(VOL ADJ)	PRESET 3	PRESET 4	—	RPT(REG)
	EUROPE	—	BAL	PRESET 3	PRESET 4	—	RPT(REG)
KS4	JAPAN	SEL FM/AM	RDM	TONE	BAL	—	T.I
	AUSTRALIA	SEL AM	LOCAL	TONE	BAL	—	RDM
	EUROPE	SEL AM	DISP(PAGE)	TONE	BAL	—	RDM(LO/DX)
	EUROPE	—	DISP(PAGE)	NEWS(RDS)	T.I.(VOL ADJ)	—	RDM(LO/DX)

GX204KEF2/KHF2/LEF2/REF2/SEF2 (2/4)

GX204KEF2/KHF2/LEF2
GX204REF2/SEF2

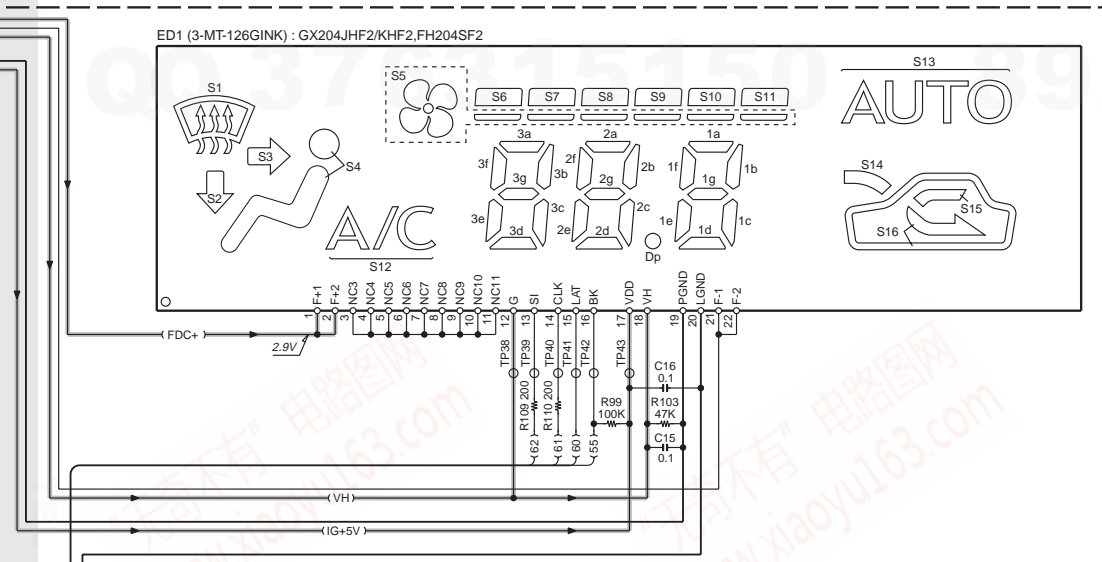

ED1 (6-MT-385GINK) : GX204JEF2/KEF2/REF2, FH204DF2

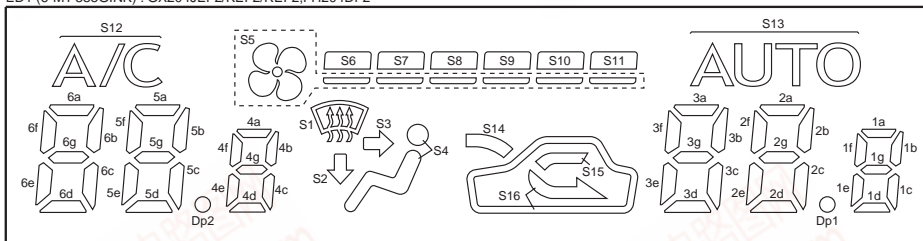

ED1 (6-MT-386GINK) : GX204LEF2/SEF2

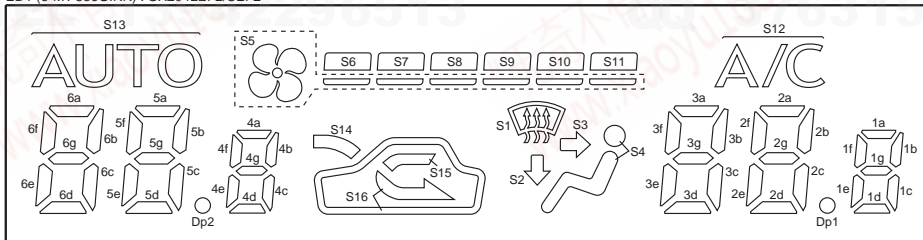

X34-401-
CN503
2/4
B

(X34-405x-xx)

MODEL NAME	UNIT No.	CN4	D4,6,8,12,16,20-22,24	D5,7,9,13,17,19,23,25,28,30,31	D18,27	D29	R18,79,84,91,98	R20,82,86,92,102	R21	R23	R27	R29	R89	R90	R112,113
GX204JEF2			YES	—	YES	—	YES	—	YES	—	YES	—	620	620	YES
GX204KEF2	0-00	YES	YES	—	YES	—	YES	—	YES	—	YES	—	620	620	YES
GX204REF2			YES	—	YES	—	YES	—	YES	—	YES	—	620	620	YES
GX204JHF2	0-01	YES	YES	—	YES	—	YES	—	YES	—	YES	—	620	620	YES
GX204KHF2	2-71	YES	—	YES	—	—	YES	YES	—	—	YES	—	620	620	YES
GX204SEF2	0-11	YES	—	YES	—	—	YES	YES	—	—	YES	—	620	620	YES
FH204DF2	0-61	—	YES	—	YES	—	YES	—	YES	—	YES	—	330	330	—
FH204SF2	0-62	—	YES	—	YES	—	YES	—	YES	—	YES	—	330	470	—

— GND LINE
— +B LINE

IC1 : MB89537A1010E
IC2 : S-80842CNNB-G
IC3 : BR24L01AF-W

Q1,7,13 : 2SC4081
Q2,3,5 : 2SA1576A
Q4 : DTC114EUA
Q11,12 : DTC143EUA

D4-7 : B30-1759-05
D8-13,16-25,27-31 : B30-1760-05

CAUTION : For continued safety, replace safety critical components only with manufacturer's recommended parts (refer to parts list).

⚠ Indicates safety critical components. To reduce the risk of electric shock, leakage-current or resistance measurements shall be carried out (exposed parts are acceptably insulated from the supply circuit) before the appliance is returned to the customer.

- DC voltages are as measured with a high impedance voltmeter. Values may vary slightly due to variations between individual instruments or/and units.

(0-0), (0-61)

	KR0	KR1	KR2	KR3
S18,19(S20)	S3,4	S5,6	S16	
S13	S8,9	S10,11(S12)	S23	
AUTO	—	A/C	FRONT DEF	
S7	S14,15	S21,22	S1,2	
OFF	—	—	MODE	

(0-01), (0-62)

	KR0	KR1	KR2	KR3
S18,19(S20)	S3,4	S5,6	S16	
S13	S8,9	S10,11(S12)	S23	
AUTO	—	A/C	FRONT DEF	
S7	S14,15	S21,22	S1,2	
AUTO	—	—	MODE	

(2-71), (0-11)

	KR0	KR1	KR2	KR3
S18,20(S19)	S3,4	S5,6	S16	
S13	S8,9	S10,12(S11)	S23	
REAR DEF	MODE	OFF	FRONT DEF	
S7	S14,15	S21,22	S1,2	
FRONT DEF	—	—	—	

1
2
3
4
5
6
7

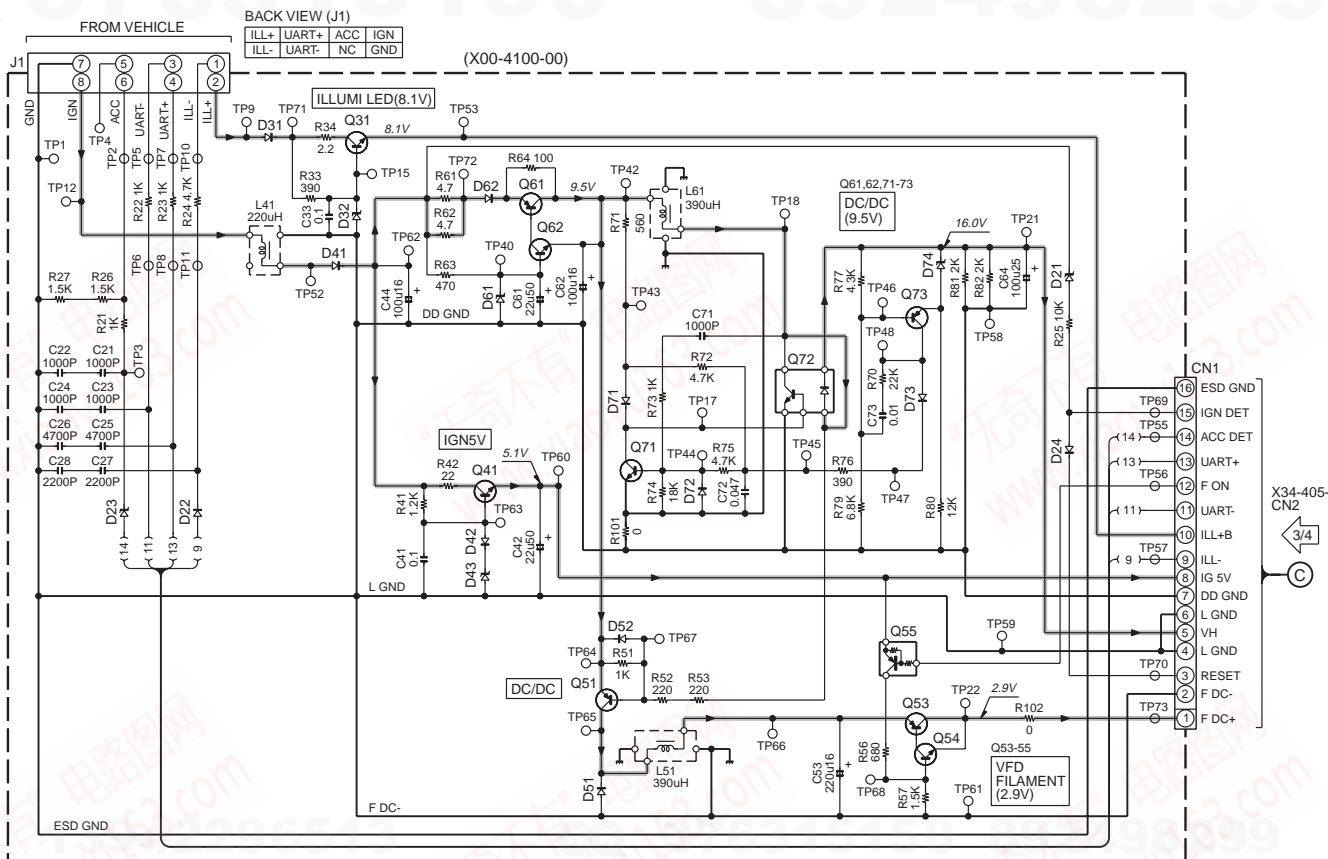

Q31, 41 : 2SD1858	D21 : HZS7L-E(A3)	D41, 62 : 1SR154-400
Q51, 53, 61 : 2SB1443	D22, 24, 31, 42, 52, 71-73	D43 : UDZS5.1B
Q54, 62, 71 : 2SC4081	D23 : 1SS133	D51 : RB160L-40
Q55 : DTA124EUA	D24 : HZS7L-E(B2)	D61 : HZS11L-E(A3)
Q72 : QSL12	D32 : HZS9L-E(B2)	D74 : UDZS5.6B
Q73 : 2SA1576A		

— GND LINE
— +B LINE

GX204KEF2/KHF2/LEF2/REF2/SEF2 (4/4)

CAUTION : For continued safety, replace safety critical components only with manufacturer's recommended parts (refer to parts list).
 ⚠ Indicates safety critical components. To reduce the risk of electric shock, leakage-current or resistance measurements shall be carried out (exposed parts are acceptably insulated from the supply circuit) before the appliance is returned to the customer.

- DC voltages are as measured with a high impedance voltmeter. Values may vary slightly due to variations between individual instruments or/and units.

UMC2N

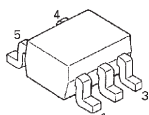

DAN202U



DAP202U
DA204U

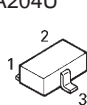

BA3121F

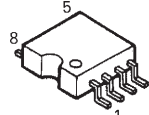

HA12187FP-E

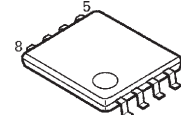

GX204KEF2/KHF2/LEF2
GX204REF2/SEF2

EXPLODED VIEW (for GX204KEF2/KHF2/REF2)

- | | | | |
|-----------------|---------------|----------------|---------------|
| A M3x4 | : N35-3004-48 | G ϕ 2x6 | : N82-2006-48 |
| C ϕ 2.6x6 | : N86-2606-48 | H ϕ 3x8 | : N09-6409-05 |
| D ϕ 2.6x8 | : N86-2608-48 | J ϕ 3x6 | : N09-6410-05 |
| E ϕ 2.6x14 | : N86-2614-48 | K ϕ 2.6x5 | : N09-6411-05 |
| F ϕ 3x8 | : N80-3008-48 | | |

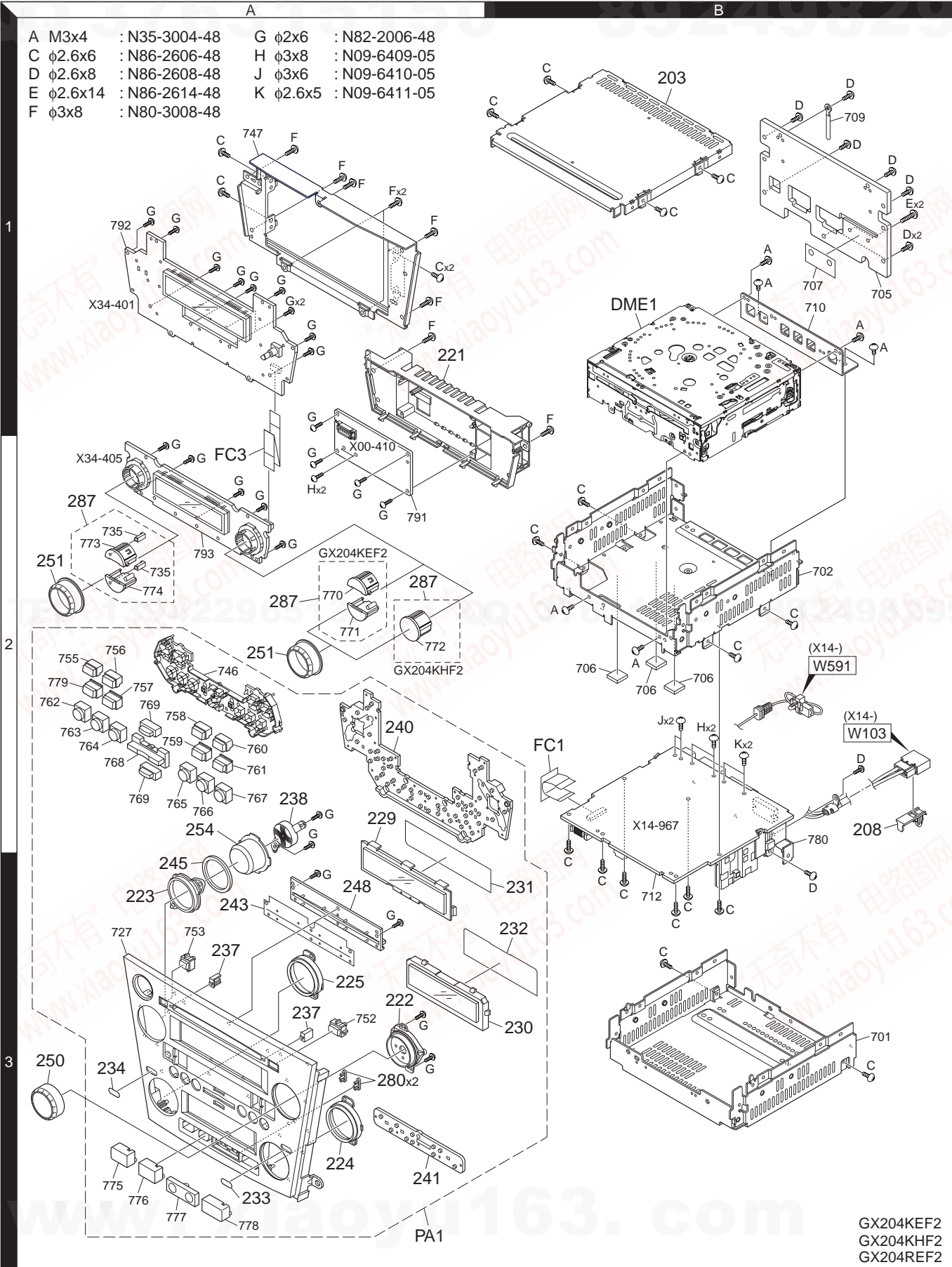

GX204KEF2
GX204KHF2
GX204REF2

EXPLODED VIEW (for GX204LEF2/SEF2)

- | | | | |
|-----------------|---------------|----------------|---------------|
| A M3x4 | : N35-3004-48 | G ϕ 2x6 | : N82-2006-48 |
| C ϕ 2.6x6 | : N86-2606-48 | H ϕ 3x8 | : N09-6409-05 |
| D ϕ 2.6x8 | : N86-2608-48 | J ϕ 3x6 | : N09-6410-05 |
| E ϕ 2.6x14 | : N86-2614-48 | K ϕ 2.6x5 | : N09-6411-05 |
| F ϕ 3x8 | : N80-3008-48 | | |

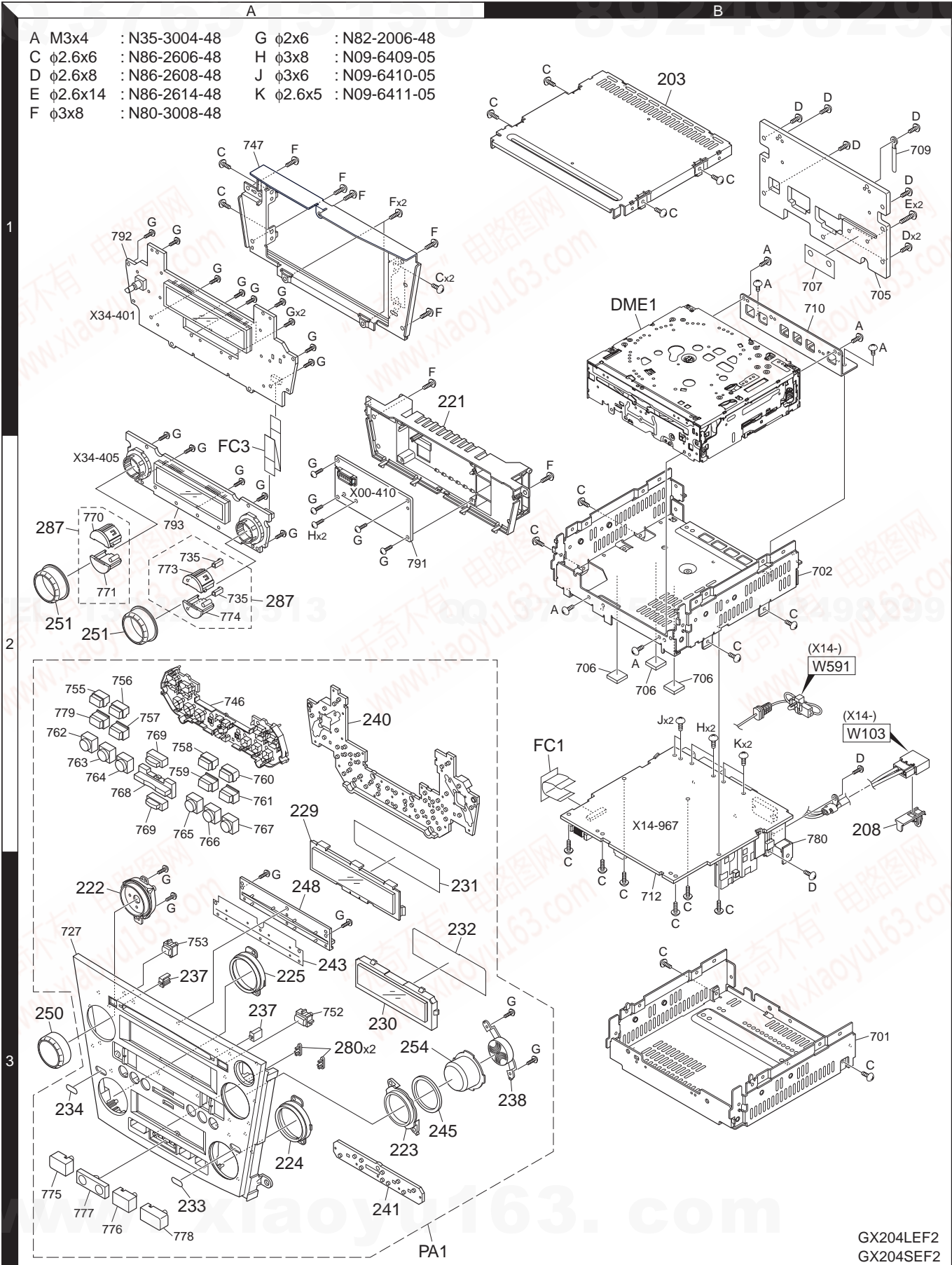

GX204LEF2
GX204SEF2

Parts with the exploded numbers larger than 700 are not supplied.

GX204KEF2/KHF2/LEF2
GX204REF2/SEF2

PARTS LIST

* New parts

Parts without **Parts No.** are not supplied.

Les articles non mentionnés dans le **Parts No.** ne sont pas fournis.

Teile ohne **Parts No.** werden nicht geliefert.

Ref. No.	A d d	N e w	Parts No.	Description	Desti- nation
GX204KEF2/KHF2/LEF2/REF2/SEF2					
203	1B	*	A52-0874-12	TOP PLATE	
DME1	1B	*	D40-2214-15	6CD MECHANISM ASSY	
FC1	2B		E39-0787-05	FLAT CABLE (6CD)	
208	2B		J19-5188-05	HOLDER	M1E1M2
208	2B	*	J19-7142-05	HOLDER	E2K1
A	1B		N35-3004-48	BINDING HEAD MACHINE SCREW	
C	1B		N86-2606-48	BINDING HEAD TAPTITE SCREW	
D	1B		N86-2608-48	BINDING HEAD TAPTITE SCREW	
E	1B		N86-2614-48	BINDING HEAD TAPTITE SCREW	
GX204KEF2/KHF2/LEF2/REF2/SEF2 (PANEL)					
221	1A		A02-2748-11	PLASTIC CABINET	
222	3A	*	A21-4650-13	DRESSING PANEL	M1E1M2
222	3A	*	A21-4651-13	DRESSING PANEL	E2K1
223	3A		A21-4652-03	DRESSING PANEL	M1E1M2
223	3A		A21-4653-03	DRESSING PANEL	E2K1
224	3A		A21-4654-03	DRESSING PANEL	
225	3A		A21-4655-03	DRESSING PANEL	
PA1		*	Y33-2570-23	PANEL ASSY	M1
PA1		*	Y33-2570-24	PANEL ASSY	M2
PA1		*	Y33-2572-73	PANEL ASSY	E1
PA1		*	Y33-2572-74	PANEL ASSY	E2
PA1		*	Y33-2570-12	PANEL ASSY	K1
229	2A	*	B10-4816-13	FRONT GLASS	
230	3A	*	B10-4818-13	FRONT GLASS	
231	3A	*	B11-1492-14	COLOR FILTER	
232	3B	*	B11-1493-14	COLOR FILTER	
233	3A		B12-1233-14	INDICATOR	
234	3A	*	B12-1234-14	INDICATOR	M2
237	3A		B19-2378-04	LIGHTING BOARD	
238	3A		B19-2379-03	LIGHTING BOARD	M1E1M2
238	3A		B19-2380-03	LIGHTING BOARD	E2K1
240	2A		E29-2072-01	CONDUCTIVE RUBBER	
241	3A		E29-2073-03	CONDUCTIVE RUBBER	M1E1M2
241	3A		E29-2077-03	CONDUCTIVE RUBBER	E2K1
FC3	2A		E39-0790-05	FLAT CABLE	
243	3A		F19-1464-04	BLIND PLATE	
245	3A		G11-3682-04	CUSHION	
248	3A		J90-1134-03	GUIDE	
250	3A		K23-1103-03	KNOB (VOL)	
251	2A		K23-1104-03	KNOB (TEMP)	
254	2A	*	K24-4483-13	PUSH KNOB (FM/AM)	M1E1M2
254	2A	*	K24-4484-13	PUSH KNOB (FM/AM)	E2K1
280	3A		K28-0117-04	KNOB BASE	
287	2A	*	K28-0157-13	KNOB SET (F/R_DEF,AUTO,OFF)	M1E1E2
287	2A	*	K28-0157-13	KNOB SET (F/R_DEF,AUTO,OFF)	K1
287	2A	*	K28-0158-13	KNOB SET (F/R_DEF,AUTO)	M2
F	1A		N80-3008-48	PAN HEAD TAPTITE SCREW	

Ref. No.	A d d	N e w	Parts No.	Description	Desti- nation
G	1A		N82-2006-48	BINDING HEAD TAPTITE SCREW	
POWER SUPPLY UNIT (X00-4100-00)					
C21-24			CK73GB1H102K	CHIP C 1000PF	K
C25,26			CK73GB1H472K	CHIP C 4700PF	K
C27,28			CK73GB1H222K	CHIP C 2200PF	K
C33			CK73GB1H104K	CHIP C 0.10UF	K
C41			CK73GB1H104K	CHIP C 0.10UF	K
C42			CD04BJ1H220M	ELECTRO 22UF 50WV	
C44			CD04AS1C101M	ELECTRO 100UF 16WV	
C53			CD04AR1C221M	ELECTRO 220UF 16WV	
C61			CD04BJ1H220M	ELECTRO 22UF 50WV	
C62			CD04AS1C101M	ELECTRO 100UF 16WV	
C64			CD04BJ1E101M	ELECTRO 100UF 25WV	
C71			CK73GB1H102K	CHIP C 1000PF	K
C72			CK73GB1H473K	CHIP C 0.047UF	K
C73			CK73GB1H103K	CHIP C 0.010UF	K
CN1			E41-2632-05	PIN ASSY	
J1			E58-1047-05	RECTANGULAR RECEPTACLE	
L41			L33-2307-05	CHOKO COIL	
L51			L33-2203-15	CHOKO COIL (390U)	
L61			L33-2203-15	CHOKO COIL (390U)	
H	2C		N09-6409-05	TAPTITE SCREW (BT 3.0X8)	
R21-23			RK73EB2E102J	CHIP R 1.0K J 1/4W	
R24			RK73EB2E472J	CHIP R 4.7K J 1/4W	
R25			RK73GB2A103J	CHIP R 10K J 1/10W	
R26,27			RK73EB2E152J	CHIP R 1.5K J 1/4W	
R33			RK73EB2E391J	CHIP R 390 J 1/4W	
R34			RK73GB2A2R2J	CHIP R 2.2 J 1/10W	
R41			RK73EB2E122J	CHIP R 1.2K J 1/4W	
R42			RK73EB2E220J	CHIP R 22 J 1/4W	
R51			RK73EB2E102J	CHIP R 1.0K J 1/4W	
R52,53			RK73EB2E221J	CHIP R 220 J 1/4W	
R56			RK73GB2A681J	CHIP R 680 J 1/10W	
R57			RK73EB2E152J	CHIP R 1.5K J 1/4W	
R61,62			RK73EB2E4R7J	CHIP R 4.7 J 1/4W	
R63			RK73EB2E471J	CHIP R 470 J 1/4W	
R64			RK73EB2E101J	CHIP R 100 J 1/4W	
R70			RK73GB2A223J	CHIP R 22K J 1/10W	
R71			RK73EB2E561J	CHIP R 560 J 1/4W	
R72			RK73GB2A472J	CHIP R 4.7K J 1/10W	
R73			RK73GB2A102J	CHIP R 1.0K J 1/10W	
R74			RK73GB2A183J	CHIP R 18K J 1/10W	
R75			RK73GB2A472J	CHIP R 4.7K J 1/10W	
R76			RK73GB2A391J	CHIP R 390 J 1/10W	
R77			RK73GB2A432J	CHIP R 4.3K J 1/10W	
R79			RD14BB2C682J	RD 6.8K J 1/6W	
R80			RD14BB2C123J	RD 12K J 1/6W	
R81,82			RK73EB2E202J	CHIP R 2.0K J 1/4W	
R101,102			RK73EB2E000J	CHIP R 0.0 J 1/4W	
D21			HZS7L-E(A3)	ZENER DIODE	
D22			1SS133	DIODE	
D23		*	HZS7L-E(B2)	ZENER DIODE	

E1 : GX204REF2 E2 : GX204LEF2 (Europe)
K1 : GX204SEF2 (North America)
M1 : GX204KEF2 M2 : GX204KHF2 (Other Areas)

△ Indicates safety critical components.

PARTS LIST

POWER SUPPLY UNIT (X00-4100-00)

Ref. No.	Add	New	Parts No.	Description	Destination
D24			1SS133	DIODE	
D31			1SS133	DIODE	
D32			HZS9L-E(B2)	ZENER DIODE	
D41			1SR154-400	DIODE	
D42			1SS133	DIODE	
D43			UDZS5.1B	ZENER DIODE	
D51			RB160L-40	DIODE	
D52			1SS133	DIODE	
D61		*	HZS11L-E(A3)	ZENER DIODE	
D62			1SR154-400	DIODE	
D71-73			1SS133	DIODE	
D74			UDZS5.6B	ZENER DIODE	
Q31			2SD1858	TRANSISTOR	
Q41			2SD1858	TRANSISTOR	
Q51			2SB1443	TRANSISTOR	
Q53			2SB1443	TRANSISTOR	
Q54			2SC4081	TRANSISTOR	
Q55			DTA124EUA	DIGITAL TRANSISTOR	
Q61			2SB1443	TRANSISTOR	
Q62			2SC4081	TRANSISTOR	
Q71			2SC4081	TRANSISTOR	
Q72			QSL12	TRANSISTOR	
Q73			2SA1576A	TRANSISTOR	
SYNTHESIZER UNIT (X14-967x-xx)					
C102			CK73GB1H103K	CHIP C 0.010UF K	M1M2
C105,106			CC73GCH1H221J	CHIP C 220PF J	M1M2
C107-109			CD04AS1V100M	ELECTRO 10UF 35WV	M1M2
C110			CC73GCH1H151J	CHIP C 150PF J	M1M2
C111			CK73GB1H103K	CHIP C 0.010UF K	M1M2
C112			CD04AS1C470M	ELECTRO 47UF 16WV	M1M2
C114			CC73GCH1H151J	CHIP C 150PF J	M1M2
C116,117			CC73GCH1H470J	CHIP C 47PF J	M1M2
C121,122			CK73GB1H103K	CHIP C 0.010UF K	M1M2
C123			CD04AS1V100M	ELECTRO 10UF 35WV	M1M2
C124			CK73GB1H473K	CHIP C 0.047UF K	M1M2
C125			CK73GB1H392K	CHIP C 3900PF K	M1M2
C126			CK73GB1H473K	CHIP C 0.047UF K	M1M2
C127			CK73GB1H333K	CHIP C 0.033UF K	M1M2
C128			CK73GB1H103K	CHIP C 0.010UF K	M1M2
C129			CC73GCH1H471J	CHIP C 470PF J	M1M2
C141,142			CD04AS1V100M	ELECTRO 10UF 35WV	E1E2
C143			CC73GCH1H471J	CHIP C 470PF J	E1E2
C144			CD04AS1V100M	ELECTRO 10UF 35WV	E1E2
C146			CC73GCH1H121J	CHIP C 120PF J	E1E2
C147			CC73GCH1H271J	CHIP C 270PF J	E1E2
C148			CK73GB1H122K	CHIP C 1200PF K	E1E2
C149			CC73GCH1H120J	CHIP C 12PF J	E1E2
C150			CC73GCH1H471J	CHIP C 470PF J	E1E2
C151			CK73GB1H822K	CHIP C 8200PF K	E1E2
C152			CC73GCH1H820J	CHIP C 82PF J	E1E2
C153			CK73GB1H222K	CHIP C 2200PF K	E1E2
C154			CK73GB1H102K	CHIP C 1000PF K	E1E2
C155			CK73GB1H122K	CHIP C 1200PF K	E1E2
C156,157			CC73GCH1H180J	CHIP C 18PF J	E1E2

Ref. No.	Add	New	Parts No.	Description	Destination
C158			CC73GCH1H060D	CHIP C 6.0PF D	E1E2
C159			CK73GB1H223K	CHIP C 0.022UF K	E1E2
C171			CK73GB1H682K	CHIP C 6800PF K	
C172			CK73GB1H473K	CHIP C 0.047UF K	
C173			CK73GB1A684K	CHIP C 0.68UF K	
C175,176			CK73GB1H333K	CHIP C 0.033UF K	
C177			CK73GB1H222K	CHIP C 2200PF K	
C178			CK73GB1H333K	CHIP C 0.033UF K	
C179			CK73GB1H223K	CHIP C 0.022UF K	
C180			CK73GB1C224K	CHIP C 0.22UF K	
C181			CK73GB1C563K	CHIP C 0.056UF K	
C182			CK73GB1H103K	CHIP C 0.010UF K	
C183			CD04AS1V100M	ELECTRO 10UF 35WV	
C184			CK73GB1H333K	CHIP C 0.033UF K	
C185			CK73GB1C224K	CHIP C 0.22UF K	
C186			CD04AS1H3R3M	ELECTRO 3.3UF 50WV	
C187			CK73GB1H102K	CHIP C 1000PF K	
C188			CC73GCH1H470J	CHIP C 47PF J	
C201-204			CD04BM1H4R7M	ELECTRO 4.7UF 50WV	
C205-208			CC73GCH1H101J	CHIP C 100PF J	
C209,210			CK73GB1H102K	CHIP C 1000PF K	
C211,212			C90-5700-05	NP-ELEC 4.7UF 16WV	
C221			CK73GB1A474K	CHIP C 0.47UF K	
C222			CD04BM1A101M	ELECTRO 100UF 10WV	
C225,226			C90-5700-05	NP-ELEC 4.7UF 16WV	
C228			CK73GB1H102K	CHIP C 1000PF K	
C229			CD04AS1V100M	ELECTRO 10UF 35WV	
C230			CK73GB1H682K	CHIP C 6800PF K	
C231			CD04AS1V100M	ELECTRO 10UF 35WV	
C233			CK73GB1H682K	CHIP C 6800PF K	
C244,245			CK73GB1H104K	CHIP C 0.10UF K	
C246			CK73GB1C224K	CHIP C 0.22UF K	
C247			CK73GB1H104K	CHIP C 0.10UF K	
C248			C90-6808-05	ELECTRO 120UF 10WV	
C251			CK73GB1H104K	CHIP C 0.10UF K	
C252			CK73GB1H473K	CHIP C 0.047UF K	
C254,255			CD04AS1V100M	ELECTRO 10UF 35WV	
C256			CK73GB1H104K	CHIP C 0.10UF K	
C257			CK73GB1H103K	CHIP C 0.010UF K	
C258			CK73GB1H473K	CHIP C 0.047UF K	
C260			CK73GB1H473K	CHIP C 0.047UF K	
C261			CK73GB1H104K	CHIP C 0.10UF K	
C262			CK73GB1H473K	CHIP C 0.047UF K	
C264			CK73GB1H473K	CHIP C 0.047UF K	
C266			CK73GB1H473K	CHIP C 0.047UF K	
C267			CK73FB1C105K	CHIP C 1.0UF K	
C268			CD04AS1V100M	ELECTRO 10UF 35WV	
C269			CK73GB1H333K	CHIP C 0.033UF K	
C270			CD04AS1V100M	ELECTRO 10UF 35WV	
C271			CC73GCH1H221J	CHIP C 220PF J	
C272			CK73GB1A474K	CHIP C 0.47UF K	
C273			CK73GB1A334K	CHIP C 0.33UF K	
C274			CK73GB1H103K	CHIP C 0.010UF K	
C276			CD04BM1C100M	ELECTRO 10UF 16WV	
C277,278			CD04AS1V100M	ELECTRO 10UF 35WV	

E1 : GX204REF2 (Europe)
K1 : GX204SEF2 (North America)
M1 : GX204KEF2 (Other Areas)

△ Indicates safety critical components.

PARTS LIST

SYNTHESIZER UNIT (X14-967x-xx)

Ref. No.	Ad	New	Parts No.	Description	Destination
C291,292			C90-6781-05	ELECTRO 4.7UF 16WV	
C293,294			CF92JV1H683J	MF C 0.068UF 50WV	
C295			C90-6781-05	ELECTRO 4.7UF 16WV	
C296-299			CC73GCH1H070D	CHIP C 7.0PF D	
C301,302			CD04BM1C100M	ELECTRO 10UF 16WV	
C304			CK73GB1H102K	CHIP C 1000PF K	
C305			CD04BJ1C221M	ELECTRO 220UF 16WV	
C306			CK73GB1H102K	CHIP C 1000PF K	
C331			CK73FB1C105K	CHIP C 1.0UF K	
C332			CD04AS1C101M	ELECTRO 100UF 16WV	
C351			CD04AS1H010M	ELECTRO 1UF 50WV	
C371,372			CD04AS1C101M	ELECTRO 100UF 16WV	
C391			CK73FB1C105K	CHIP C 1.0UF K	
C392			CD04BM1A101M	ELECTRO 100UF 10WV	
C401			CK73GB1H103K	CHIP C 0.010UF K	
C402-409			CK73GB1H392K	CHIP C 3900PF K	
C410			CC73GCH1H070D	CHIP C 7.0PF D	
C412			CK73FB1C105K	CHIP C 1.0UF K	
C413			CD04BM1A101M	ELECTRO 100UF 10WV	
C414			CC73GCH1H070D	CHIP C 7.0PF D	
C416			CC73GCH1H070D	CHIP C 7.0PF D	
C418			CK73FB1C105K	CHIP C 1.0UF K	
C420			CC73GCH1H070D	CHIP C 7.0PF D	
C421			CK73GB1H102K	CHIP C 1000PF K	
C501,502			CD04AS1HR47M	ELECTRO 0.47UF 50WV	
C505			CD04AS1C101M	ELECTRO 100UF 16WV	
C506			CD04AS1V100M	ELECTRO 10UF 35WV	
C507			CK73GB1H102K	CHIP C 1000PF K	
C508			CD04AS1V100M	ELECTRO 10UF 35WV	
C521,522			CC73GCH1H821J	CHIP C 820PF J	
C551,552			CD04AS1H4R7M	ELECTRO 4.7UF 50WV	
C555			CD04AS1C220M	ELECTRO 22UF 16WV	
C556			CD04AS1H010M	ELECTRO 1UF 50WV	
C557			CK73GB1H104K	CHIP C 0.10UF K	
C558,559			CK73GB1H103K	CHIP C 0.010UF K	
C591			CK73GB1H103K	CHIP C 0.010UF K	E1E2
C601			CK73FB1E474K	CHIP C 0.47UF K	
C602,603			CD04BD1C101M	ELECTRO 100UF 16WV	
C604			CC73GCH1H101J	CHIP C 100PF J	
C606			CK73GB1H104K	CHIP C 0.10UF K	
C607			CK73GB1H103K	CHIP C 0.010UF K	
C609			CD04AY1H470M	ELECTRO 47UF 50WV	
C621			CK73GB1H104K	CHIP C 0.10UF K	
C622			CD04BA1H3R3M	ELECTRO 3.3UF 50WV	
C623			CK73GB1H103K	CHIP C 0.010UF K	
C651			CK73FB1C105K	CHIP C 1.0UF K	
C652			CD04AT0J331M	ELECTRO 330UF 6.3WV	
C653			C90-5647-05	ELECTRO 0.047F 5.5WV	
C655			CD04AS0J101M	ELECTRO 100UF 6.3WV	
C672			CD04AT1E101M	ELECTRO 100UF 25WV	
C673			C90-6808-05	ELECTRO 120UF 10WV	
C682			CD04AS1C470M	ELECTRO 47UF 16WV	
C691			CK73GB1H104K	CHIP C 0.10UF K	
C701			CC73GCH1H070D	CHIP C 7.0PF D	
C702			C90-6783-05	ELECTRO 3900 16WV	

Ref. No.	Ad	New	Parts No.	Description	Destination
C711			CK73GB1H122K	CHIP C 1200PF K	
C721			CK73GB1H122K	CHIP C 1200PF K	
C751			CK73GB1H102K	CHIP C 1000PF K	
C802			CK73GB1H104K	CHIP C 0.10UF K	
C804			CK73GB1H102K	CHIP C 1000PF K	
C805			CC73GCH1H120J	CHIP C 12PF J	
C806			CK73GB1H104K	CHIP C 0.10UF K	
C807			CC73GCH1H120J	CHIP C 12PF J	
C808			CD04AS1H010M	ELECTRO 1UF 50WV	
C809			CK73GB1H104K	CHIP C 0.10UF K	
C811			CD04AS1H4R7M	ELECTRO 4.7UF 50WV	
C812,813			CK73GB1H104K	CHIP C 0.10UF K	
C971,972			CC73GCH1H150J	CHIP C 15PF J	
C977			CK73GB1H104K	CHIP C 0.10UF K	
CN1			E40-9760-05	PIN ASSY	
CN4			E41-2346-05	FLAT CABLE CONNECTOR	
J1			E58-0985-05	RECTANGULAR RECEPTACLE	
J2			E58-0930-05	RECTANGULAR RECEPTACLE	
J3			E58-0954-05	RECTANGULAR RECEPTACLE	
W103	2B	*	E30-6502-15	CORD WITH PLUG	M1M2
W103	2B	*	E30-6503-15	CORD WITH PLUG	E1E2K1
W591	2B	*	E30-4810-05	CORD WITH CONNECTOR	E1E2
F331		*	F53-0394-05	FUSE 2.5A	
F501			F53-0306-05	FUSE (UL,CSA) 5A	
F601			F53-0374-05	FUSE 1.5A	
L105			L33-2260-05	CHOKE COIL (52M)	
L107			L41-4795-33	SMALL FIXED INDUCTOR (4.7U)	M1M2
L121			L33-2318-05	SMALL FIXED INDUCTOR (560U)	M1M2
L171			L33-1815-05	LINE FILTER	
L601			L33-2317-05	SMALL FIXED INDUCTOR (22U)	
L602			L33-2203-15	CHOKE COIL (390U)	
L671			L33-2262-05	CHOKE COIL (100U)	
L701			L33-2303-05	CHOKE COIL	
X141			L77-2002-05	CRYSTAL RESONATOR	E1E2
X801			L77-2830-05	CRYSTAL RESONATOR (12.582MHZ CL	
D	2D		N86-2608-48	BINDING HEAD TAPTITE SCREW	
H	2D		N09-6409-05	TAPTITE SCREW (BT 3.0X8)	
J	2D		N09-6410-05	TAPTITE SCREW (BT 3.0X6)	
K	2D		N09-6411-05	TAPPING SCREW (2.6X5)	
CP371			RK74GA1J104J	CHIP-COM 100K J 1/16W	
R101			RK73GB2A223J	CHIP R 22K J 1/10W	
R102			RK73GB2A472J	CHIP R 4.7K J 1/10W	
R103			RK73GB2A220J	CHIP R 22 J 1/10W	E1E2
R104			RK73GB2A472J	CHIP R 4.7K J 1/10W	E1E2
R105-107			RK73GB2A2R2J	CHIP R 2.2 J 1/10W	
R108			RK73GB2A102J	CHIP R 1.0K J 1/10W	E1E2
R109			RK73GB2A103J	CHIP R 10K J 1/10W	
R110			RK73GB2A472J	CHIP R 4.7K J 1/10W	
R111			RK73GB2A1R0J	CHIP R 1.0 J 1/10W	
R112			RK73GB2A000J	CHIP R 0.0 J 1/10W	E1E2K1
R121			RK73GB2A2R2J	CHIP R 2.2 J 1/10W	M1M2
R122,123			RK73GB2A222J	CHIP R 2.2K J 1/10W	M1M2
R124			RK73GB2A683J	CHIP R 68K J 1/10W	M1M2
R125			RK73GB2A154J	CHIP R 150K J 1/10W	M1M2

E1 : GX204REF2 E2 : GX204LEF2 (Europe)
K1 : GX204SEF2 (North America)
M1 : GX204KEF2 M2 : GX204KHF2 (Other Areas)

△ Indicates safety critical components.

PARTS LIST

SYNTHESIZER UNIT (X14-967x-xx)

Ref. No.	Add	New	Parts No.	Description	Destination	Ref. No.	Add	New	Parts No.	Description	Destination
R126			RK73GB2A561J	CHIP R 560 J 1/10W	M1M2	R271			RK73GB2A823J	CHIP R 82K J 1/10W	
R127			RK73GB2A222J	CHIP R 2.2K J 1/10W	M1M2	R272			RK73GB2A104J	CHIP R 100K J 1/10W	
R131			RK73GB2A103J	CHIP R 10K J 1/10W	M1M2	R273			RK73GB2A1R0J	CHIP R 1.0 J 1/10W	
R141			RK73GB2A2R2J	CHIP R 2.2 J 1/10W	E1E2	R274			RK73GB2A912J	CHIP R 9.1K J 1/10W	
R142			RK73GB2A103J	CHIP R 10K J 1/10W	E1E2	R275			RK73GB2A622J	CHIP R 6.2K J 1/10W	
R143			RK73GB2A272J	CHIP R 2.7K J 1/10W	E1E2	R276			RK73GB2A103J	CHIP R 10K J 1/10W	
R144			RK73GB2A563J	CHIP R 56K J 1/10W	E1E2	R277			RK73GB2A182J	CHIP R 1.8K J 1/10W	
R145-148			RK73GB2A103J	CHIP R 10K J 1/10W	E1E2	R278			RK73GB2A100J	CHIP R 10 J 1/10W	
R149			RK73GB2A153J	CHIP R 15K J 1/10W	E1E2	R291-294			RK73GB2A221J	CHIP R 220 J 1/10W	
R150			RK73GB2A103J	CHIP R 10K J 1/10W	E1E2	R295			RK73GB2A471J	CHIP R 470 J 1/10W	
R151			RK73GB2A102J	CHIP R 1.0K J 1/10W	E1E2	R301			RK73GB2A472J	CHIP R 4.7K J 1/10W	
R152			RK73GB2A562J	CHIP R 5.6K J 1/10W	E1E2	R302			RK73GB2A682J	CHIP R 6.8K J 1/10W	
R153			RK73GB2A104J	CHIP R 100K J 1/10W	E1E2	R303			RK73GB2A272J	CHIP R 2.7K J 1/10W	
R154			RK73GB2A103J	CHIP R 10K J 1/10W	E1E2	R304,305			RK73GB2A102J	CHIP R 1.0K J 1/10W	
R155			RK73GB2A823J	CHIP R 82K J 1/10W	E1E2	R308			RK73GB2A222J	CHIP R 2.2K J 1/10W	
R156			RK73GB2A562J	CHIP R 5.6K J 1/10W	E1E2	R309			RK73GB2A332J	CHIP R 3.3K J 1/10W	
R157			RK73GB2A102J	CHIP R 1.0K J 1/10W	E1E2	R310			RK73GB2A102J	CHIP R 1.0K J 1/10W	
R171			RK73GB2A392J	CHIP R 3.9K J 1/10W		R311			RK73EB2E221J	CHIP R 220 J 1/4W	
R172			RK73GB2A101J	CHIP R 100 J 1/10W		R312			RK73GB2A103J	CHIP R 10K J 1/10W	
R173			RK73GB2A124J	CHIP R 120K J 1/10W		R313			RK73GB2A391J	CHIP R 390 J 1/10W	
R174			RK73GB2A473J	CHIP R 47K J 1/10W		R314			RK73GB2A223J	CHIP R 22K J 1/10W	
R175			RK73GB2A123J	CHIP R 12K J 1/10W		R315-318			RK73GB2A103J	CHIP R 10K J 1/10W	
R176			RK73GB2A104J	CHIP R 100K J 1/10W		R319			RK73GB2A432J	CHIP R 4.3K J 1/10W	
R177			RK73GB2A473J	CHIP R 47K J 1/10W		R331,332			RD14DB2H3R3J	SMALL-RD 3.3 J 1/2W	
R178			RK73GB2A272J	CHIP R 2.7K J 1/10W		R333			RK73GB2A182J	CHIP R 1.8K J 1/10W	
R179			RK73GB2A2R2J	CHIP R 2.2 J 1/10W		R334			RK73GB2A104J	CHIP R 100K J 1/10W	
R201,202			RK73GH2A153D	CHIP R 15K D 1/10W		R351			RK73EB2E1R0J	CHIP R 1.0 J 1/4W	
R203,204			RK73GB2A6R2J	CHIP R 6.2 J 1/10W		R352,353			RK73EB2E222J	CHIP R 2.2K J 1/4W	
R205-210			RK73GH2A153D	CHIP R 15K D 1/10W		R354			RK73GB2A100J	CHIP R 10 J 1/10W	
R211,212			RK73GB2A102J	CHIP R 1.0K J 1/10W		R355			RK73GB2A104J	CHIP R 100K J 1/10W	
R215,216			RK73GH2A561D	CHIP R 560 D 1/10W		R356			RK73EB2E103J	CHIP R 10K J 1/4W	
R217,218			RK73GB2A102J	CHIP R 1.0K J 1/10W		R371			RK73GB2A223J	CHIP R 22K J 1/10W	
R219,220			RK73GB2A473J	CHIP R 47K J 1/10W		R372			RK73GB2A104J	CHIP R 100K J 1/10W	
R221			RK73GB2A472J	CHIP R 4.7K J 1/10W		R373			RK73GB2A153J	CHIP R 15K J 1/10W	
R222			RK73GB2A1R0J	CHIP R 1.0 J 1/10W		R374,375			RK73GB2A334J	CHIP R 330K J 1/10W	
R223,224			RK73GB2A102J	CHIP R 1.0K J 1/10W		R391			RK73GB2A472J	CHIP R 4.7K J 1/10W	
R225-229			RK73GB2A472J	CHIP R 4.7K J 1/10W		R392			RK73EB2E561J	CHIP R 560 J 1/4W	
R230			RK73GB2A1R0J	CHIP R 1.0 J 1/10W		R393			RK73EB2E1R0J	CHIP R 1.0 J 1/4W	
R231			RK73GB2A103J	CHIP R 10K J 1/10W		R394			RK73EB2E561J	CHIP R 560 J 1/4W	
R233,234			RK73GB2A332J	CHIP R 3.3K J 1/10W		R401			RK73EB2E472J	CHIP R 4.7K J 1/4W	
R235,236			RK73GB2A113J	CHIP R 11K J 1/10W		R402-409			RK73GB2A104J	CHIP R 100K J 1/10W	
R237-240			RK73GB2A201J	CHIP R 200 J 1/10W		R410			RK73GB2A333J	CHIP R 33K J 1/10W	
R255			RK73GB2A332J	CHIP R 3.3K J 1/10W		R411			RK73GB2A100J	CHIP R 10 J 1/10W	
R257			RK73GB2A222J	CHIP R 2.2K J 1/10W		R412			RK73EB2E472J	CHIP R 4.7K J 1/4W	
R258,259			RK73GB2A103J	CHIP R 10K J 1/10W		R501-504			RK73EB2E102J	CHIP R 1.0K J 1/4W	
R260			RK73GB2A104J	CHIP R 100K J 1/10W		R505-507			RK73EB2E100J	CHIP R 10 J 1/4W	
R261			RK73GB2A332J	CHIP R 3.3K J 1/10W		R508			RK73EB2E751J	CHIP R 750 J 1/4W	
R263			RK73GB2A104J	CHIP R 100K J 1/10W		R509			RK73EB2E680J	CHIP R 68 J 1/4W	
R264			RK73GB2A103J	CHIP R 10K J 1/10W		R521,522			RK73GB2A473J	CHIP R 47K J 1/10W	
R265			RK73GB2A222J	CHIP R 2.2K J 1/10W		R523			RK73EB2E101J	CHIP R 100 J 1/4W	
R266			RK73GB2A473J	CHIP R 47K J 1/10W		R524			RK73GB2A620J	CHIP R 62 J 1/10W	
R267			RK73GB2A363J	CHIP R 36K J 1/10W		R525			RK73EB2E101J	CHIP R 100 J 1/4W	
R268			RK73GB2A103J	CHIP R 10K J 1/10W		R526-528			RK73GB2A102J	CHIP R 1.0K J 1/10W	
R269			RK73GB2A134J	CHIP R 130K J 1/10W		R529			RK73GB2A473J	CHIP R 47K J 1/10W	
R270			RK73GB2A104J	CHIP R 100K J 1/10W		R530			RK73GB2A392J	CHIP R 3.9K J 1/10W	

E1 : GX204REF2 (Europe)
K1 : GX204SEF2 (North America)
M1 : GX204KEF2 (Other Areas)

△ Indicates safety critical components.

PARTS LIST

SYNTHESIZER UNIT (X14-967x-xx)

Ref. No.	Ad	New	Parts No.	Description	Destination
R551,552			RK73EB2E100J	CHIP R 10 J 1/4W	E1E2
R553			RK73EB2E4R7J	CHIP R 4.7 J 1/4W	
R554			RK73EB2E104J	CHIP R 100K J 1/4W	
R555			RK73EB2E820J	CHIP R 82 J 1/4W	
R556			RK73EB2E102J	CHIP R 1.0K J 1/4W	
R591			RK73EB2E752J	CHIP R 7.5K J 1/4W	
R601			RK73GB2A471J	CHIP R 470 J 1/10W	
R602,603			RK73EB2E2R2J	CHIP R 2.2 J 1/4W	
R604			RK73EB2E750J	CHIP R 75 J 1/4W	
R606			RK73GB2A221J	CHIP R 220 J 1/10W	
R607			RK73GB2A123J	CHIP R 12K J 1/10W	
R608,609			RK73GB2A622J	CHIP R 6.2K J 1/10W	
R610			RK73GB2A333J	CHIP R 33K J 1/10W	
R611			RK73GB2A391J	CHIP R 390 J 1/10W	
R612			RK73GB2A223J	CHIP R 22K J 1/10W	
R613			RK73GB2A622J	CHIP R 6.2K J 1/10W	
R614			RK73GB2A682J	CHIP R 6.8K J 1/10W	
R615			RK73GB2A333J	CHIP R 33K J 1/10W	
R616			RK73EB2E750J	CHIP R 75 J 1/4W	
R617			RK73GB2A473J	CHIP R 47K J 1/10W	
R621-623			RD14DB2H240J	SMALL-RD 24 J 1/2W	
R624			RK73GB2A222J	CHIP R 2.2K J 1/10W	
R626,627			RD14DB2H682J	SMALL-RD 6.8K J 1/2W	
R628			RK73FB2B273J	CHIP R 27K J 1/8W	
R629			RK73GB2A153J	CHIP R 15K J 1/10W	
R630,631			RK73GB2A101J	CHIP R 100 J 1/10W	
R632			RD14DB2H240J	SMALL-RD 24 J 1/2W	
R633			RK73FB2B621J	CHIP R 620 J 1/8W	
R651			RK73GB2A123J	CHIP R 12K J 1/10W	
R652			RK73EB2E2R2J	CHIP R 2.2 J 1/4W	
R653			RK73GB2A2R2J	CHIP R 2.2 J 1/10W	
R654			RK73EB2E2R2J	CHIP R 2.2 J 1/4W	
R655			RK73GB2A1R0J	CHIP R 1.0 J 1/10W	
R671			RK73EB2E1R0J	CHIP R 1.0 J 1/4W	
R672			RK73GB2A473J	CHIP R 47K J 1/10W	
R673			RK73GB2A471J	CHIP R 470 J 1/10W	
R674			RK73GB2A2R2J	CHIP R 2.2 J 1/10W	
R681			RK73EB2E1R0J	CHIP R 1.0 J 1/4W	
R691			RK73EB2E2R2J	CHIP R 2.2 J 1/4W	
R692			RK73GB2A122J	CHIP R 1.2K J 1/10W	
R693			RK73EB2E122J	CHIP R 1.2K J 1/4W	
R694			RK73GB2A472J	CHIP R 4.7K J 1/10W	
R711			RK73GB2A103J	CHIP R 10K J 1/10W	
R712			RK73GB2A223J	CHIP R 22K J 1/10W	
R713			RK73EB2E152J	CHIP R 1.5K J 1/4W	
R714			RK73GB2A222J	CHIP R 2.2K J 1/10W	
R715			RK73GB2A133J	CHIP R 13K J 1/10W	
R716			RK73EB2E152J	CHIP R 1.5K J 1/4W	
R721			RK73GB2A103J	CHIP R 10K J 1/10W	
R722			RK73GB2A223J	CHIP R 22K J 1/10W	
R723			RK73GB2A133J	CHIP R 13K J 1/10W	
R751			RK73GB2A473J	CHIP R 47K J 1/10W	
R752			RK73GB2A101J	CHIP R 100 J 1/10W	
R801			RK73GB2A103J	CHIP R 10K J 1/10W	
R802			RK73GB2A103J	CHIP R 10K J 1/10W	

Ref. No.	Ad	New	Parts No.	Description	Destination
R802,803			RK73GB2A103J	CHIP R 10K J 1/10W	E1
R803			RK73GB2A103J	CHIP R 10K J 1/10W	E2
R804,805			RK73GB2A103J	CHIP R 10K J 1/10W	M1K1M2
R806			RK73GB2A103J	CHIP R 10K J 1/10W	E1E2
R808			RK73GB2A103J	CHIP R 10K J 1/10W	
R810			RK73GB2A103J	CHIP R 10K J 1/10W	
R815			RK73GB2A473J	CHIP R 47K J 1/10W	
R816			RK73GB2A102J	CHIP R 1.0K J 1/10W	
R817			RK73GB2A301J	CHIP R 300 J 1/10W	
R818			RK73GB2A473J	CHIP R 47K J 1/10W	
R819			RK73GB2A102J	CHIP R 1.0K J 1/10W	
R820			RK73GB2A103J	CHIP R 10K J 1/10W	
R821,822			RK73GB2A473J	CHIP R 47K J 1/10W	
R823			RK73GB2A472J	CHIP R 4.7K J 1/10W	
R824-831			RK73GB2A102J	CHIP R 1.0K J 1/10W	
R832			RK73GB2A473J	CHIP R 47K J 1/10W	
R836-838			RK73GB2A102J	CHIP R 1.0K J 1/10W	
R839			RK73GB2A223J	CHIP R 22K J 1/10W	
R840			RK73GB2A102J	CHIP R 1.0K J 1/10W	
R841,842			RK73GB2A473J	CHIP R 47K J 1/10W	
R843			RK73GB2A102J	CHIP R 1.0K J 1/10W	
R844			RK73GB2A222J	CHIP R 2.2K J 1/10W	
R845			RK73GB2A473J	CHIP R 47K J 1/10W	M1K1M2
R846,847			RK73GB2A103J	CHIP R 10K J 1/10W	
R848			RK73GB2A222J	CHIP R 2.2K J 1/10W	E1E2
R849			RK73GB2A473J	CHIP R 47K J 1/10W	
R850			RK73GB2A103J	CHIP R 10K J 1/10W	
R851			RK73GB2A222J	CHIP R 2.2K J 1/10W	E1E2
R852			RK73GB2A473J	CHIP R 47K J 1/10W	
R853-855			RK73GB2A102J	CHIP R 1.0K J 1/10W	
R856			RK73GB2A473J	CHIP R 47K J 1/10W	
R857			RK73GB2A222J	CHIP R 2.2K J 1/10W	
R858-860			RK73GB2A102J	CHIP R 1.0K J 1/10W	
R861			RK73GB2A471J	CHIP R 470 J 1/10W	E1E2
R862			RK73GB2A473J	CHIP R 47K J 1/10W	
R863			RK73GB2A101J	CHIP R 100 J 1/10W	
R864			RK73GB2A473J	CHIP R 47K J 1/10W	M1K1M2
R865,866			RK73GB2A101J	CHIP R 100 J 1/10W	
R867			RK73GB2A473J	CHIP R 47K J 1/10W	
R868			RK73GB2A102J	CHIP R 1.0K J 1/10W	
R869			RK73GB2A101J	CHIP R 100 J 1/10W	
R870			RK73GB2A473J	CHIP R 47K J 1/10W	M1K1M2
R871			RK73GB2A101J	CHIP R 100 J 1/10W	
R872			RK73GB2A473J	CHIP R 47K J 1/10W	
R873,874			RK73GB2A102J	CHIP R 1.0K J 1/10W	
R876			RK73GB2A473J	CHIP R 47K J 1/10W	
R877			RK73GB2A392J	CHIP R 3.9K J 1/10W	
R878			RK73GB2A472J	CHIP R 4.7K J 1/10W	
R879			RK73GB2A222J	CHIP R 2.2K J 1/10W	
R880			RK73GB2A103J	CHIP R 10K J 1/10W	
R881,882			RK73GB2A472J	CHIP R 4.7K J 1/10W	
R883,884			RK73GB2A102J	CHIP R 1.0K J 1/10W	
R885			RK73GB2A154J	CHIP R 150K J 1/10W	
R886-888			RK73GB2A102J	CHIP R 1.0K J 1/10W	
R890			RK73GB2A101J	CHIP R 100 J 1/10W	

E1 : GX204REF2 E2 : GX204LEF2 (Europe)
K1 : GX204SEF2 (North America)
M1 : GX204KEF2 M2 : GX204KHF2 (Other Areas)

△ Indicates safety critical components.

PARTS LIST

SYNTHESIZER UNIT (X14-967x-xx)

Ref. No.	Add	New	Parts No.	Description	Destination	Ref. No.	Add	New	Parts No.	Description	Destination
R892			RK73GB2A101J	CHIP R 100 J 1/10W		D802			1SS133	DIODE	
R893-895			RK73GB2A102J	CHIP R 1.0K J 1/10W	M1M2	D804,805			DAP202U	DIODE	
R894,895			RK73GB2A102J	CHIP R 1.0K J 1/10W	E1E2K1	IC121			TA2083AFNG	ANALOGUE IC	M1M2
R900			RK73GB2A101J	CHIP R 100 J 1/10W		IC141			E-TDA7479AD	ANALOGUE IC	E1E2
R901			RK73GB2A222J	CHIP R 2.2K J 1/10W		IC143			NJM4565V-ZB	ANALOGUE IC	E1E2
R902			RK73GB2A101J	CHIP R 100 J 1/10W		IC171			HA12181FP-E	ANALOGUE IC	
R903			RK73GB2A222J	CHIP R 2.2K J 1/10W		IC201			NJM4565V-ZB	ANALOGUE IC	
R904-907			RK73GB2A473J	CHIP R 47K J 1/10W		IC221			E-TDA7406	ANALOGUE IC	
R908			RK73GB2A472J	CHIP R 4.7K J 1/10W		IC222			NJM4565V-ZB	ANALOGUE IC	
R909,910			RK73GB2A473J	CHIP R 47K J 1/10W		IC251			NJM2195FJ1-ZA	ANALOGUE IC	
R912			RK73GB2A222J	CHIP R 2.2K J 1/10W		IC301			NJM4565V-ZB	ANALOGUE IC	
R914			RK73GB2A222J	CHIP R 2.2K J 1/10W		IC391			BA08CC0T	ANALOGUE IC	
R915			RK73GB2A102J	CHIP R 1.0K J 1/10W		IC401			E-TDA7384A	ANALOGUE IC	
R916,917			RK73GB2A473J	CHIP R 47K J 1/10W		IC521			HA12187FP-E	ANALOGUE IC	
R971,972			RK73GH2A130D	CHIP R 13 D 1/10W		IC551			BA3121F	ANALOGUE IC	
R973-977			RK73GB2A473J	CHIP R 47K J 1/10W		IC651			SI-3033LUSNF	ANALOGUE IC	
R978,979			RK73GB2A2R4F	CHIP R 2.4 F 1/10W		IC671			SI-8050JDNF	ANALOGUE IC	
D101			IMS A-6802-E	SURGE ABSORBER	E1E2K1	IC681			SI-3033LSANF	ANALOGUE IC	
D101,102			IMS A-6802-E	SURGE ABSORBER	M1M2	IC751		*	TC7W02FU-F	MOS-IC	
D121			1SV237-F	DIODE	M1M2	IC801			703037HYGM04A	MICROCONTROLLER IC	
D141			1SS133	DIODE	E1E2	IC802			S-80842CNNB-G	MOS-IC	
D221			DAP202U	DIODE		IC952			TC74VHCT32AFT	MOS-IC	
D301		*	HZS7L-E(A3)	ZENER DIODE		Q101			DTC144EUA	DIGITAL TRANSISTOR	
D302,303			DAN202U	DIODE		Q102			UMF5N	TRANSISTOR	
D331		*	HZS9L-E(B2)	ZENER DIODE		Q103			2SC4081	TRANSISTOR	E1E2
D351			1SS133	DIODE		Q121			DTC114EUA	DIGITAL TRANSISTOR	M1M2
D371		*	HZS6L-E(B1)	ZENER DIODE		Q122			2SK3018	FET	M1M2
D401			DAN202U	DIODE		Q123			UMC2N	TRANSISTOR	M1M2
D501			FTZ6.8E	ZENER DIODE		Q124			DTC124EUA	DIGITAL TRANSISTOR	M1M2
D503			STZ6.8N	ZENER DIODE		Q141			DTC114TUA	DIGITAL TRANSISTOR	E1E2
D504			FTZ6.8E	ZENER DIODE		Q142			2SC4081	TRANSISTOR	E1E2
D521			STZ6.8N	ZENER DIODE		Q143			DTA124EUA	DIGITAL TRANSISTOR	E1E2
D551			FTZ6.8E	ZENER DIODE		Q221,222			DTC124EUA	DIGITAL TRANSISTOR	
D552			STZ6.8N	ZENER DIODE		Q223,224			DTC343TK	DIGITAL TRANSISTOR	
D601		*	HZS12L-E(B1)	ZENER DIODE		Q301			DTC114YUA	DIGITAL TRANSISTOR	
D602			1SS133	DIODE		Q303			DTC124EUA	DIGITAL TRANSISTOR	
D603			UDZS3.3B	ZENER DIODE		Q304			2SC4081	TRANSISTOR	
D604			UDZS5.6B	ZENER DIODE		Q331			UMC2N	TRANSISTOR	
D605			1SS133	DIODE		Q332			2SB1184	TRANSISTOR	
D606			EP05Q06	DIODE		Q333			2SC4081	TRANSISTOR	
D621		*	HZS6L-E(C3)	ZENER DIODE		Q351			DTA114EUA	DIGITAL TRANSISTOR	
D622,623			1SR154-400	DIODE		Q352			2SB1443	TRANSISTOR	
D624			1SS133	DIODE		Q353			2SC4081	TRANSISTOR	
D651			UDZS5.1B	ZENER DIODE		Q354			DTC143EUA	DIGITAL TRANSISTOR	
D671			RB160L-40	DIODE		Q371,372			2SA1576A	TRANSISTOR	
D691			UDZS10B	ZENER DIODE		Q373			2SC4081	TRANSISTOR	
D701		*	ST70-27F-5072	ZENER DIODE		Q391			DTC114YUA	DIGITAL TRANSISTOR	
D711		*	HZS7L-E(A3)	ZENER DIODE		Q392			2SB1443	TRANSISTOR	
D712			DAN202U	DIODE		Q521,522			DTA124EUA	DIGITAL TRANSISTOR	
D721		*	HZS7L-E(A3)	ZENER DIODE		Q523,524			DTC144EUA	DIGITAL TRANSISTOR	
D722			UDZS10B	ZENER DIODE		Q525			DTC114EUA	DIGITAL TRANSISTOR	
D751			DAN202U	DIODE		Q526			DTA114EUA	DIGITAL TRANSISTOR	
D752			DAP202U	DIODE		Q551			DTA124EUA	DIGITAL TRANSISTOR	
D801			RB717F	DIODE		Q601			DTA124EUA	DIGITAL TRANSISTOR	
						Q602			2SB1443	TRANSISTOR	

E1 : GX204REF2 E2 : GX204LEF2 (Europe)
K1 : GX204SEF2 (North America)
M1 : GX204KEF2 M2 : GX204KHF2 (Other Areas)

△ Indicates safety critical components.

PARTS LIST

SYNTHESIZER UNIT (X14-967x-xx)

Ref. No.	Added	New	Parts No.	Description	Destination
Q603			2SC4081	TRANSISTOR	
Q604			2SC3392	TRANSISTOR	
Q605			2SC5824	TRANSISTOR	
Q606			2SA1576A	TRANSISTOR	
Q621			UMC2N	TRANSISTOR	
Q622			2SB1184	TRANSISTOR	
Q623			2SC4081	TRANSISTOR	
Q624			DTC114EUA	DIGITAL TRANSISTOR	
Q625			2SA1576A	TRANSISTOR	
Q626			2SB1184	TRANSISTOR	
Q651			2SB1184	TRANSISTOR	
Q652			2SC4081	TRANSISTOR	
Q671,672			DTC144EUA	DIGITAL TRANSISTOR	
Q673			2SA1577	TRANSISTOR	
Q674			DTC114YUA	DIGITAL TRANSISTOR	
Q691			UMC2N	TRANSISTOR	
Q692			2SB1184	TRANSISTOR	
Q693			2SC4081	TRANSISTOR	
Q694			2SC4097	TRANSISTOR	
Q711			2SC4081	TRANSISTOR	
Q721			2SC4081	TRANSISTOR	
Q722			DTC144EUA	DIGITAL TRANSISTOR	
Q801			2SA1576A	TRANSISTOR	
Q802			UMC2N	TRANSISTOR	
Q803			DTA114EUA	DIGITAL TRANSISTOR	
Q804,805			DTC144EUA	DIGITAL TRANSISTOR	
Q806			DTA143EUA	DIGITAL TRANSISTOR	
Q807			DTA124EUA	DIGITAL TRANSISTOR	
Q808,809			DTC124EUA	DIGITAL TRANSISTOR	
Q810			DTA124EUA	DIGITAL TRANSISTOR	
A1			X86-3980-11	FRONT-END UNIT	M1K1M2
A1			X86-3982-70	FRONT-END UNIT	E1E2
SWITCH UNIT (X34-401x-xx) (AUDIO)					
D502-505			B30-1760-05	LED (1608 RED)	
D508-517			B30-1760-05	LED (1608 RED)	
D524-535			B30-1760-05	LED (1608 RED)	
C501,502			CK73GB1H104K	CHIP C 0.10UF K	
C505-511			CK73GB1H104K	CHIP C 0.10UF K	
C513			CC73GCH1H070D	CHIP C 7.0PF D	
C521			CK73GB1H104K	CHIP C 0.10UF K	
CN501			E41-2531-05	SOCKET FOR PIN ASSY	
CN503			E41-2163-05	FLAT CABLE CONNECTOR	
X501			L78-1214-05	RESONATOR (4MHZ)	
CP1			RK74GB1J102J	CHIP-COM 1.0K J 1/16W	
CP2			RK74GB1J222J	CHIP-COM 2.2K J 1/16W	
CP3			RK74GB1J473J	CHIP-COM 47K J 1/16W	
CP4,5			RK74GB1J222J	CHIP-COM 2.2K J 1/16W	
CP6			RK74GB1J473J	CHIP-COM 47K J 1/16W	
CP7			RK74GB1J102J	CHIP-COM 1.0K J 1/16W	
CP8			RK74GB1J222J	CHIP-COM 2.2K J 1/16W	
CP9			RK74GB1J472J	CHIP-COM 4.7K J 1/16W	
CP10			RK74GB1J473J	CHIP-COM 47K J 1/16W	
R501			RK73GB2A181J	CHIP R 180 J 1/10W	

Ref. No.	Added	New	Parts No.	Description	Destination
R502-505			RK73EB2E8R2J	CHIP R 8.2 J 1/4W	
R506			RK73FB2B561J	CHIP R 560 J 1/8W	
R507,508			RK73EB2E8R2J	CHIP R 8.2 J 1/4W	
R509			RK73FB2B621J	CHIP R 620 J 1/8W	
R510			RK73PB2H100J	CHIP R 10 J 1/2W	
R512			RK73PB2H100J	CHIP R 10 J 1/2W	
R513,514			RK73FB2B751J	CHIP R 750 J 1/8W	
R515,516			RK73FB2B391J	CHIP R 390 J 1/8W	
R518			RK73GB2A103J	CHIP R 10K J 1/10W	
R526			RK73FB2B561J	CHIP R 560 J 1/8W	
R528			RK73FB2B561J	CHIP R 560 J 1/8W	
R529			RK73GB2A102J	CHIP R 1.0K J 1/10W	
R531			RK73GB2A102J	CHIP R 1.0K J 1/10W	
R538			RK73FB2B751J	CHIP R 750 J 1/8W	
R539			RK73GB2A222J	CHIP R 2.2K J 1/10W	
R540			RK73GB2A104J	CHIP R 100K J 1/10W	
R553			RK73GB2A102J	CHIP R 1.0K J 1/10W	
R554,555			RK73GB2A103J	CHIP R 10K J 1/10W	
R556			RK73GB2A102J	CHIP R 1.0K J 1/10W	
R557			RK73GB2A103J	CHIP R 10K J 1/10W	
R558			RK73GB2A102J	CHIP R 1.0K J 1/10W	
R561			RK73GB2A151J	CHIP R 150 J 1/10W	
R562			RK73GB2A102J	CHIP R 1.0K J 1/10W	
R563			RK73GB2A151J	CHIP R 150 J 1/10W	
R564			RK73GB2A102J	CHIP R 1.0K J 1/10W	
R565			RK73GB2A103J	CHIP R 10K J 1/10W	M1E1M2
R567			RK73GB2A103J	CHIP R 10K J 1/10W	E2K1
R570-572			RK73GB2A201J	CHIP R 200 J 1/10W	
R573			RK73GB2A473J	CHIP R 47K J 1/10W	
R583			RK73GB2A102J	CHIP R 1.0K J 1/10W	
R585,586			RK73EB2E102J	CHIP R 1.0K J 1/4W	
R587			RK73GB2A100J	CHIP R 10 J 1/10W	
R588			RK73GB2A3R3J	CHIP R 3.3 J 1/10W	
R590,591			RK73FB2B561J	CHIP R 560 J 1/8W	
R592			RK73FB2B751J	CHIP R 750 J 1/8W	
R601			RK73GB2A100J	CHIP R 10 J 1/10W	
R995-997			RK73GB2A221J	CHIP R 220 J 1/10W	
S501			T99-0470-05	ROTARY ENCODER	E2K1
S502			T99-0470-05	ROTARY ENCODER	M1E1M2
D501			HZM2.0N-E(B)	ZENER DIODE	
D536			DA204U	DIODE	
ED1			13-BT-227GINK	FLUORESCENT INDICATOR TUBE	
IC501			MB90562A-419E	MICROCONTROLLER IC	
IC502			BR24L02FV-W	ROM IC	
Q501			2SB1184	TRANSISTOR	
Q502			DTA114EUA	DIGITAL TRANSISTOR	
SWITCH UNIT (X34-405x-xx) (H/C)					
D4			B30-1759-05	LED (1608 AMBER)	M1E1M2
D5			B30-1759-05	LED (1608 AMBER)	E2K1
D6			B30-1759-05	LED (1608 AMBER)	M1E1M2
D7			B30-1759-05	LED (1608 AMBER)	E2K1
D8			B30-1760-05	LED (1608 RED)	M1E1M2
D9-11			B30-1760-05	LED (1608 RED)	E2K1

PARTS LIST

SWITCH UNIT (X34-405x-xx) (H/C)

Ref. No.	Add	New	Parts No.	Description	Destination	Ref. No.	Add	New	Parts No.	Description	Destination
D10-12			B30-1760-05	LED (1608 RED)	M1E1M2	R29			RK73GB2A103J	CHIP R 10K J 1/10W	E2
D13			B30-1760-05	LED (1608 RED)	E2K1	R37			RK73GB2A472J	CHIP R 4.7K J 1/10W	
D16			B30-1760-05	LED (1608 RED)	M1E1M2	R44			RK73GB2A562J	CHIP R 5.6K J 1/10W	
D17			B30-1760-05	LED (1608 RED)	E2K1	R49			RK73GB2A473J	CHIP R 47K J 1/10W	
D18			B30-1760-05	LED (1608 RED)	M1E1	R50,51			RK73GB2A223J	CHIP R 22K J 1/10W	
D19			B30-1760-05	LED (1608 RED)	E2K1	R54			RK73GB2A102J	CHIP R 1.0K J 1/10W	
D20-22			B30-1760-05	LED (1608 RED)	M1E1M2	R59,60			RK73GB2A102J	CHIP R 1.0K J 1/10W	
D23			B30-1760-05	LED (1608 RED)	E2K1	R62			RK73GB2A472J	CHIP R 4.7K J 1/10W	
D24			B30-1760-05	LED (1608 RED)	M1E1M2	R64,65			RK73GB2A000J	CHIP R 0.0 J 1/10W	
D25			B30-1760-05	LED (1608 RED)	E2K1	R68-70			RK73GB2A222J	CHIP R 2.2K J 1/10W	
D27			B30-1760-05	LED (1608 RED)	M1E1	R71			RK73GB2A472J	CHIP R 4.7K J 1/10W	
D28			B30-1760-05	LED (1608 RED)	E2K1	R72			RK73GB2A473J	CHIP R 47K J 1/10W	
D29			B30-1760-05	LED (1608 RED)	M2	R76			RK73GB2A472J	CHIP R 4.7K J 1/10W	
D30,31			B30-1760-05	LED (1608 RED)	E2K1	R78			RK73GB2A472J	CHIP R 4.7K J 1/10W	
						R79			RK73FB2B221J	CHIP R 220 J 1/8W	M1E1M2
C1			CK73GB1H104K	CHIP C 0.10UF K		R82			RK73FB2B221J	CHIP R 220 J 1/8W	E2K1
C3			CC73GCH1H471J	CHIP C 470PF J		R84			RK73FB2B221J	CHIP R 220 J 1/8W	M1E1M2
C6			CK73GB1H104K	CHIP C 0.10UF K		R86			RK73FB2B221J	CHIP R 220 J 1/8W	E2K1
C8,9			CC73GCH1H270J	CHIP C 27PF J		R87,88			RK73GB2A472J	CHIP R 4.7K J 1/10W	
C11,12			CK73GB1H104K	CHIP C 0.10UF K		R89			RK73FB2B621J	CHIP R 620 J 1/8W	M2
C13			CK73GB1H103K	CHIP C 0.010UF K		R89,90			RK73FB2B621J	CHIP R 620 J 1/8W	M1E1E2
C15,16			CK73GB1H104K	CHIP C 0.10UF K		R89,90			RK73FB2B621J	CHIP R 620 J 1/8W	K1
285			E29-2074-04	CONDUCTIVE RUBBER (S7,13,16,23)	M2	R90			RK73FB2B821J	CHIP R 820 J 1/8W	M2
286			E29-2075-04	CONDUCTIVE RUBBER (S7,13)		R91			RK73FB2B201J	CHIP R 200 J 1/8W	M1E1M2
CN2			E41-2631-05	SOCKET FOR PIN ASSY		R92			RK73FB2B201J	CHIP R 200 J 1/8W	E2K1
CN4			E41-2163-05	FLAT CABLE CONNECTOR		R93			RK73GB2A472J	CHIP R 4.7K J 1/10W	
X1			L77-2925-05	CRYSTAL RESONATOR (12.288MHZ)		R96,97			RK73GB2A472J	CHIP R 4.7K J 1/10W	
CP1-3			RK74GB1J102J	CHIP-COM 1.0K J 1/16W		R98			RK73FB2B331J	CHIP R 330 J 1/8W	M1E1M2
CP4			RK74GA1J102J	CHIP-COM 1.0K J 1/16W		R99			RK73GB2A104J	CHIP R 100K J 1/10W	
R1,2			RK73EB2E221J	CHIP R 220 J 1/4W		R100			RK73GB2A472J	CHIP R 4.7K J 1/10W	
R3			RK73GB2A103J	CHIP R 10K J 1/10W		R101			RK73GB2A331J	CHIP R 330 J 1/10W	
R4			RK73GB2A471J	CHIP R 470 J 1/10W		R102			RK73FB2B331J	CHIP R 330 J 1/8W	E2K1
R5,6			RK73GB2A472J	CHIP R 4.7K J 1/10W		R103			RK73GB2A473J	CHIP R 47K J 1/10W	
R7			RK73GB2A361J	CHIP R 360 J 1/10W		R104,105			RK73GB2A472J	CHIP R 4.7K J 1/10W	
R8			RK73GB2A821J	CHIP R 820 J 1/10W		R106,107			RK73GB2A222J	CHIP R 2.2K J 1/10W	
R9			RK73GB2A151J	CHIP R 150 J 1/10W		R108			RK73GB2A473J	CHIP R 47K J 1/10W	
R10			RK73GB2A562J	CHIP R 5.6K J 1/10W		R109,110			RK73GB2A201J	CHIP R 200 J 1/10W	
R11			RK73GB2A103J	CHIP R 10K J 1/10W		R111,112			RK73GB2A102J	CHIP R 1.0K J 1/10W	
R12			RK73GB2A102J	CHIP R 1.0K J 1/10W		R113			RK73GB2A2R2J	CHIP R 2.2 J 1/10W	
R13			RK73GB2A473J	CHIP R 47K J 1/10W		R114,115			RK73FB2B821J	CHIP R 820 J 1/8W	
R14			RK73GB2A102J	CHIP R 1.0K J 1/10W		S17			T99-0469-05	ROTARY ENCODER	
R15			RK73GB2A101J	CHIP R 100 J 1/10W		S24			T99-0469-05	ROTARY ENCODER	
R16			RK73GB2A102J	CHIP R 1.0K J 1/10W		ED1			3-MT-126GINK	FLUORESCENT INDICATOR TUBE	M2
R17			RK73GB2A101J	CHIP R 100 J 1/10W		ED1			6-MT-385GINK	FLUORESCENT INDICATOR TUBE	M1E1
R18			RK73GB2A103J	CHIP R 10K J 1/10W	M1E1M2	ED1			6-MT-386GINK	FLUORESCENT INDICATOR TUBE	E2K1
R19			RK73GB2A153J	CHIP R 15K J 1/10W		IC1			MB89537A1010E	MICROCONTROLLER IC	
R20,21			RK73GB2A103J	CHIP R 10K J 1/10W	E2K1	IC2			S-80842CNNB-G	MOS-IC	
R21			RK73GB2A103J	CHIP R 10K J 1/10W	M1E1	IC3			BR24L01AF-W	ROM IC	
R22			RK73GB2A512J	CHIP R 5.1K J 1/10W		Q1			2SC4081	TRANSISTOR	
R23			RK73GB2A103J	CHIP R 10K J 1/10W	M2	Q2,3			2SA1576A	TRANSISTOR	
R24			RK73GB2A102J	CHIP R 1.0K J 1/10W		Q4			DTC114EUA	DIGITAL TRANSISTOR	
R25			RK73GB2A472J	CHIP R 4.7K J 1/10W		Q5			2SA1576A	TRANSISTOR	
R27			RK73GB2A103J	CHIP R 10K J 1/10W	M1E1K1	Q7			2SC4081	TRANSISTOR	
R27			RK73GB2A103J	CHIP R 10K J 1/10W	M2	Q11,12			DTC143EUA	DIGITAL TRANSISTOR	

E1 : GX204REF2 E2 : GX204LEF2 (Europe)
K1 : GX204SEF2 (North America)
M1 : GX204KEF2 M2 : GX204KHF2 (Other Areas)

△ Indicates safety critical components.

PARTS LIST

SWITCH UNIT (X34-405x-xx) (H/C)

Ref. No.	A d d	N e w	Parts No.	Description	Desti- nation
Q13			2SC4081	TRANSISTOR	

Ref. No.	A d d	N e w	Parts No.	Description	Desti- nation
----------	-------------	-------------	-----------	-------------	------------------

E1 : GX204REF2 E2 : GX204LEF2 (Europe)
K1 : GX204SEF2 (North America)
M1 : GX204KEF2 M2 : GX204KHF2 (Other Areas)

△ Indicates safety critical components.

PARTS LIST

CAPACITORS

CC 45 TH 1H 220 J
1 2 3 4 5 6

- 1 = Type ... ceramic, electrolytic, etc.
- 2 = Shape ... round, square, etc.
- 3 = Temp. coefficient
- 4 = Voltage rating
- 5 = Value
- 6 = Tolerance

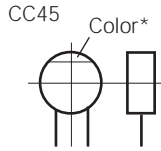

Capacitor value

- 010 = 1pF
- 100 = 10pF
- 101 = 100pF
- 102 = 1000pF = 0.001μF
- 103 = 0.01μF

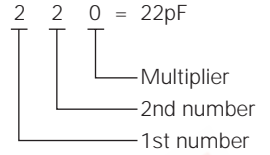

Temperature coefficient

1st Word	C	L	P	R	S	T	U
Color*	Black	Red	Orange	Yellow	Green	Blue	Violet
ppm/°C	0	-80	-150	-220	-330	-470	-750

2nd Word	G	H	J	K	L
ppm/°C	±30	±60	±120	±250	±500

Example : CC45TH = -470±60ppm/°C

Tolerance (More than 10pF)

Code	C	D	G	J	K	M	X	Z	P	No code
(%)	±0.25	±0.5	±2	±5	±10	±20	+40 -20	+80 -20	+100 -0	More than 10μF : -10~+50 Less than 4.7μF : -10~+75

(Less than 10pF)

Code	B	C	D	F	G
(pF)	±0.1	±0.25	±0.5	±1	±2

Voltage rating

2nd word \ 1st word	A	B	C	D	E	F	G	H	J	K	V
0	1.0	1.25	1.6	2.0	2.5	3.15	4.0	5.0	6.3	8.0	-
1	10	12.5	16	20	25	31.5	40	50	63	80	35
2	100	125	160	200	250	315	400	500	630	800	-
3	1000	1250	1600	2000	2500	2150	4000	5000	6300	8000	-

Chip capacitors

(EX) CC 73 F SL 1H 000 J
1 2 3 4 5 6 7
(Chip) (CH, RH, UJ, SL)

(EX) CK 73 F F 1H 000 Z
1 2 3 4 5 6 7
(Chip) (B, F)

Refer to the table above.

- 1 = Type
- 2 = Shape
- 3 = Dimension
- 4 = Temp. coefficient
- 5 = Voltage rating
- 6 = Value
- 7 = Tolerance

Dimension

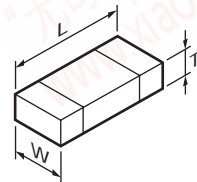

Chip capacitor

Code	L	W	T
Empty	5.6±0.5	5.0±0.5	Less than 2.0
A	4.5±0.5	3.2±0.4	Less than 2.0
B	4.5±0.5	2.0±0.3	Less than 2.0
C	4.5±0.5	1.25±0.2	Less than 1.25
D	3.2±0.4	2.5±0.3	Less than 1.5
E	3.2±0.2	1.6±0.2	Less than 1.25
F	2.0±0.3	1.25±0.2	Less than 1.25
G	1.6±0.2	0.8±0.2	Less than 1.0
H	1.0±0.05	0.5±0.05	0.5±0.05

Chip resistor

Code	L	W	T
E	3.2±0.2	1.6±0.2	1.0
F	2.0±0.3	1.25±0.2	1.0
G	1.6±0.2	0.8±0.2	0.5±0.1
H	1.0±0.05	0.5±0.05	0.35±0.05

RESISTORS

Chip resistor (Carbon)

(EX) RD 73 E B 2B 000 J
1 2 3 4 5 6 7
(Chip) (B, F)

Carbon resistor (Normal type)

(EX) RD 14 B B 2C 000 J
1 2 3 4 5 6 7

- 1 = Type
- 2 = Shape
- 3 = Dimension
- 4 = Temp. coefficient
- 5 = Rating wattage
- 6 = Value
- 7 = Tolerance

Rating wattage

Code	Wattage	Code	Wattage	Code	Wattage
1J	1/16W	2C	1/6W	3A	1W
2A	1/10W	2E	1/4W	3D	2W
2B	1/8W	2H	1/2W		

SPECIFICATIONS

FM : GX204LEF2/REF2

Frequency Range 87.5~108.0MHz
Channel Space Selection 50kHz
Usable Sensitivity (S/N=26dB) 6dB μ V EMF
Signal to Noise Ratio (MONO) 60dB
Selectivity (\pm 300kHz) 80dB
Stereo Separation (1kHz) 30dB

FM : GX204KEF2/KHF2/SEF2

Frequency Range 87.5~108.0MHz
Channel Space Selection 100kHz
Usable Sensitivity (S/N=30dB) 6dB μ V EMF
Signal to Noise Ratio (MONO) 65dB
Selectivity (\pm 300kHz) 80dB
Stereo Separation (1kHz) 30dB

MW, LW : GX204LEF2/REF2

Frequency Range
MW 531~1611kHz
LW 153~281kHz
Channel Space Selection
MW 9kHz
LW 1kHz
Usable Sensitivity (S/N 20dB)
MW 29dB μ V EMF
LW 35dB μ V EMF

AM : GX204KEF2/KHF2/SEF2

Frequency Range 531~1629kHz
Channel Space Selection 9k/10kHz
Usable Sensitivity (S/N 20dB) 29dB μ V EMF

CD

Digital Filter 8 Times Over Sampling
D/A Converter 1Bit
Total Harmonic Distoytion 0.1% (1kHz)
S/N Ratio 73dB (1kHz)
Channel Separation 70dB (1kHz)

Audio

Maximum Output Power 20W x 4 (4 Ω)
Tone Action
Bass : 100Hz \pm 10dB
Mid : 396Hz \pm 10dB
Treble : 6.34kHz \pm 10dB

General

Operating Voltage 13.2V (10.8~15.6V)
Current Consumption 10A

KENWOOD follows a policy of continuous advancements in development. For this reason specifications may be changed without notice.

DANGER:

Please do not look at the laser beam directly during repair or operation check.